

# DUAL WINDING, SHIELDING INDUCTORS

## SDRH0703D SERIES

### Description:

- Four sizes of shielded drum core inductors
- Windings can be connected in series or parallel offering a broadrange of inductance and current ratings
- Surface Mount

### Packaging:

- Supplied in tape and reel packaging  
1350 (DRQ73), 1100 (DRQ74)  
600 (DRQ125), and 350 (DRQ127)  
per reel

### Applications:

- As a transformer: SEPIC, flyback
- As an inductor: buck, boost, coupled inductor
- DC-DC converters
- VRM inductor for CPU and DDR power supplies
- Input and output filter chokes

## ELECTRICAL CHARACTERISTICS:

Part Number	Rated Inductance (uH)	Parallel ratings					Series ratings				
		OCL ± 20% (uH) ①	I <sub>rms</sub> (A) ②	I <sub>sat</sub> (A) ③	DCR (Ω) ④	Volt u-sec ⑤	OCL ± 20% (uH) ①	I <sub>rms</sub> (A) ②	I <sub>sat</sub> (A) ③	DCR (Ω) ④	Volt u-sec ⑤
SDRH0703D-R33M	0.33	0.306	6.19	14.4	0.0074	1.98	1.224	3.10	7.18	0.0296	3.96
SDRH0703D-1R0M	1.0	0.992	5.25	7.97	0.0103	3.56	3.968	2.63	3.99	0.0411	7.12
SDRH0703D-1R5M	1.5	1.482	4.64	6.52	0.0132	4.36	5.928	2.32	3.26	0.0527	8.72
SDRH0703D-2R2M	2.2	2.070	4.11	5.52	0.0167	5.15	8.280	2.06	2.76	0.0669	10.3
SDRH0703D-3R3M	3.3	3.540	3.31	4.22	0.0259	6.73	14.16	1.66	2.11	0.1035	13.5
SDRH0703D-4R7M	4.7	4.422	3.09	3.78	0.0297	7.52	17.69	1.55	1.89	0.1188	15.0
SDRH0703D-6R8M	6.8	6.480	2.55	3.12	0.0435	9.11	25.92	1.28	1.56	0.1742	18.2
SDRH0703D-8R2M	8.2	8.930	2.19	2.66	0.0592	10.7	35.72	1.10	1.33	0.2368	21.4
SDRH0703D-100M	10	10.30	2.08	2.47	0.0656	11.5	41.20	1.04	1.24	0.2623	23.0
SDRH0703D-150M	15	15.01	1.83	2.05	0.0844	13.9	60.04	0.916	1.03	0.339	27.8
SDRH0703D-220M	22	22.65	1.62	1.67	0.107	17.0	90.60	0.811	0.83	0.429	34.0
SDRH0703D-330M	33	34.41	1.31	1.35	0.166	21.0	137.6	0.653	0.68	0.665	42.0
SDRH0703D-470M	47	48.62	1.08	1.14	0.241	24.9	194.5	0.542	0.57	0.965	49.8
SDRH0703D-680M	68	68.91	0.89	0.96	0.358	29.7	275.6	0.444	0.48	1.43	59.4
SDRH0703D-820M	82	80.37	0.86	0.89	0.384	32.1	321.5	0.430	0.44	1.54	64.2
SDRH0703D-101M	100	101.4	0.73	0.79	0.527	36.0	405.6	0.367	0.39	2.11	72.0
SDRH0703D-151M	150	150.9	0.58	0.65	0.851	44.0	603.6	0.289	0.32	3.41	88.0
SDRH0703D-221M	220	223.3	0.52	0.53	1.05	53.5	893.2	0.260	0.27	4.20	107
SDRH0703D-331M	330	325.3	0.42	0.44	1.59	64.5	1302	0.211	0.22	6.36	129
SDRH0703D-471M	470	465.8	0.35	0.37	2.36	77.2	1863	0.173	0.18	9.44	154
SDRH0703D-681M	680	676.5	0.29	0.31	3.47	93.1	2706	0.143	0.15	13.88	186
SDRH0703D-821M	820	821.7	0.27	0.28	3.93	103	3287	0.134	0.14	15.72	206
SDRH0703D-102M	1000	995.0	0.26	0.25	4.34	113	3980	0.128	0.13	17.36	226

- 1) Open Circuit Inductance Test Parameters: 100kHz, 0.25 Vrms, 0.0 Adc Parallel: (1,2 -4,3) Series: (1-4) tie (2-3)
- 2) RMS current for an approximate DT of 40°C without core loss. It is recommended that the temperature of the part not exceed 125°C.
- 3) Peak current for approximately 30% roll-off at 20°C
- 4) DCR limits @ 20°C
- 5) Applied Volt-Time product (V-μ S) across the inductor. This value represents the applied V-μ Sat 100kHz necessary to generate a core loss equal to 10% of the total losses for a 40° C temperature rise.

## SCHEMATIC

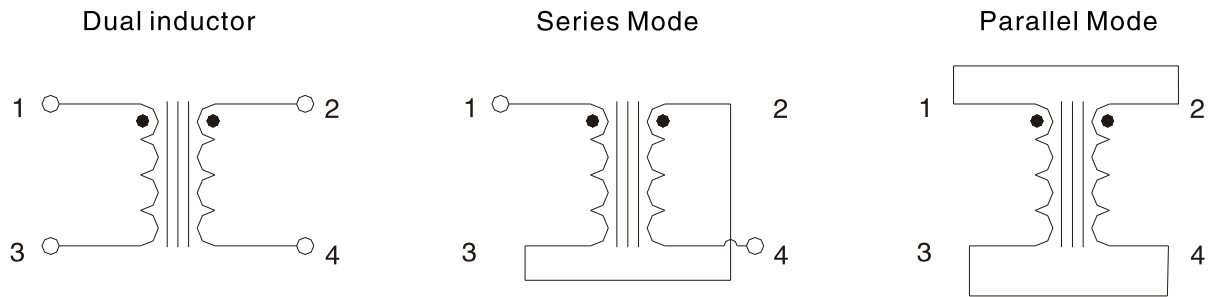

## PHYSICAL CHARACTERISTICS(Dimensions:mm)

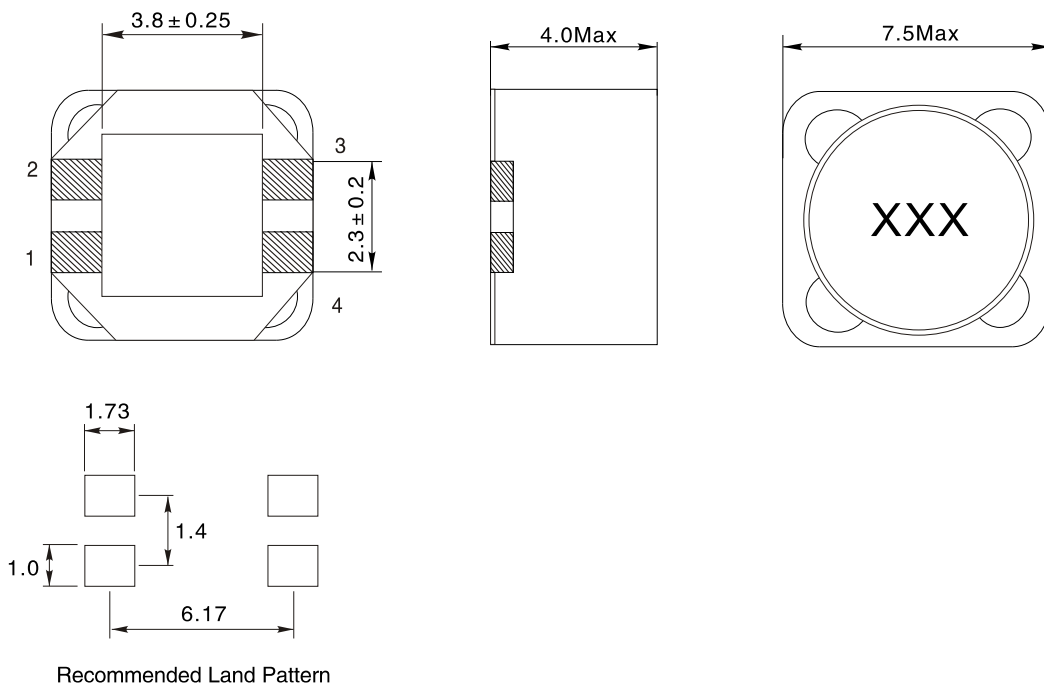

### Notes:

1. 200Vac Isolation between windings
2. Storage temperature:  $-40^{\circ}\text{C}$  to  $+125^{\circ}\text{C}$
3. Operating temperature:  $-40^{\circ}\text{C}$  to  $+125^{\circ}\text{C}$  (range is application specific).
4. Solder reflow temperature:  $260^{\circ}\text{C}$  max. for 10 seconds max.
5. Turns Ratio (1:3):(2-4)=1:1
6. All specifications subject to change without notice.

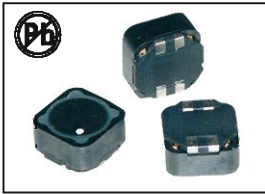

# DUAL WINDING, SHIELDING INDUCTORS

## SDRH0704D SERIES

### Description:

- Four sizes of shielded drum core inductors
- Windings can be connected in series or parallel offering a broadrange of inductance and current ratings
- Surface Mount

### Packaging:

- Supplied in tape and reel packaging 1350 (DRQ73), 1100 (DRQ74) 600 (DRQ125), and 350 (DRQ127) per reel

### Applications:

- As a transformer: SEPIC, flyback
- As an inductor: buck, boost, coupled inductor
- DC-DC converters
- VRM inductor for CPU and DDR power supplies
- Input and output filter chokes

## ELECTRICAL CHARACTERISTICS:

Part Number	Rated Inductance (uH)	Parallel ratings					Series ratings				
		OCL ±20% (uH) ①	I <sub>rms</sub> (A) ②	I <sub>sat</sub> (A) ③	DCR (Ω) ④	Volt u-sec ⑤	OCL ±20% (uH) ①	I <sub>rms</sub> (A) ②	I <sub>sat</sub> (A) ③	DCR (Ω) ④	Volt u-sec ⑤
SDRH0704D-R33M	0.33	0.294	6.20	18.4	0.0074	1.71	1.176	3.10	9.18	0.0295	3.42
SDRH0704D-1R0M	1.0	0.952	5.33	10.2	0.0100	3.08	3.808	2.66	5.10	0.0400	6.16
SDRH0704D-1R5M	1.5	1.422	4.96	8.35	0.0115	3.76	5.688	2.48	4.17	0.0461	7.52
SDRH0704D-2R2M	2.2	1.986	4.66	7.06	0.0130	4.45	7.944	2.33	3.53	0.0521	8.9
SDRH0704D-3R3M	3.3	3.396	3.94	5.40	0.0183	5.81	13.58	1.97	2.70	0.0732	11.6
SDRH0704D-4R7M	4.7	5.182	3.34	4.37	0.0254	7.18	20.73	1.67	2.19	0.102	14.4
SDRH0704D-6R8M	6.8	7.344	2.60	3.67	0.0418	8.55	29.38	1.30	1.84	0.167	17.1
SDRH0704D-8R2M	8.2	8.566	2.53	3.40	0.0441	9.23	34.26	1.27	1.70	0.177	18.5
SDRH0704D-100M	10	9.882	2.41	3.17	0.0489	9.92	39.53	1.20	1.58	0.196	19.8
SDRH0704D-150M	15	16.09	2.11	2.48	0.0637	12.7	64.36	1.05	1.24	0.255	25.4
SDRH0704D-220M	22	21.73	1.75	2.13	0.0925	14.7	86.92	0.874	1.07	0.371	29.4
SDRH0704D-330M	33	33.01	1.41	1.73	0.143	18.1	132.0	0.702	0.87	0.574	36.2
SDRH0704D-470M	47	49.64	1.15	1.41	0.216	22.2	198.6	0.573	0.71	0.865	44.4
SDRH0704D-680M	68	69.67	1.03	1.19	0.265	26.3	278.7	0.517	0.60	1.06	52.6
SDRH0704D-820M	82	80.95	0.91	1.11	0.345	28.4	323.8	0.453	0.55	1.38	56.8
SDRH0704D-101M	100	101.6	0.86	0.99	0.383	31.8	406.4	0.430	0.49	1.53	63.6
SDRH0704D-151M	150	150.0	0.69	0.81	0.591	38.6	600.0	0.346	0.41	2.37	77.2
SDRH0704D-221M	220	227.0	0.56	0.66	0.907	47.5	908.0	0.279	0.33	3.63	95
SDRH0704D-331M	330	335.6	0.45	0.54	1.41	57.8	1342	0.224	0.27	5.66	116
SDRH0704D-471M	470	465.3	0.40	0.46	1.74	68.1	1861	0.202	0.23	6.97	136
SDRH0704D-681M	680	671.2	0.33	0.38	2.58	81.7	2685	0.166	0.19	10.3	163
SDRH0704D-821M	820	812.7	0.31	0.35	2.93	89.9	3251	0.156	0.17	11.7	180
SDRH0704D-102M	1000	1009	0.27	0.31	3.89	100	4036	0.135	0.16	15.6	200

- 1) Open Circuit Inductance Test Parameters: 100kHz, 0.25 Vrms, 0.0 A dc Parallel: (1, 2 - 4, 3) Series: (1-4) tie (2-3)
- 2) RMS current for an approximate DT of 40°C without core loss. It is recommended that the temperature of the part not exceed 125°C.
- 3) Peak current for approximately 30% roll-off at 20°C
- 4) DCR limits @ 20°C
- 5) Applied Volt-Time product (V-μs) across the inductor. This value represents the applied V-μs at 100kHz necessary to generate a core loss equal to 10% of the total losses for a 40°C temperature rise.

## SCHEMATIC

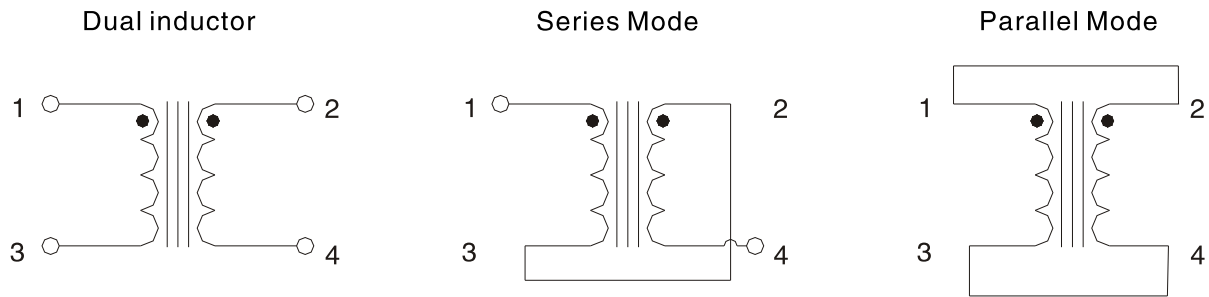

## PHYSICAL CHARACTERISTICS(Dimensions:mm)

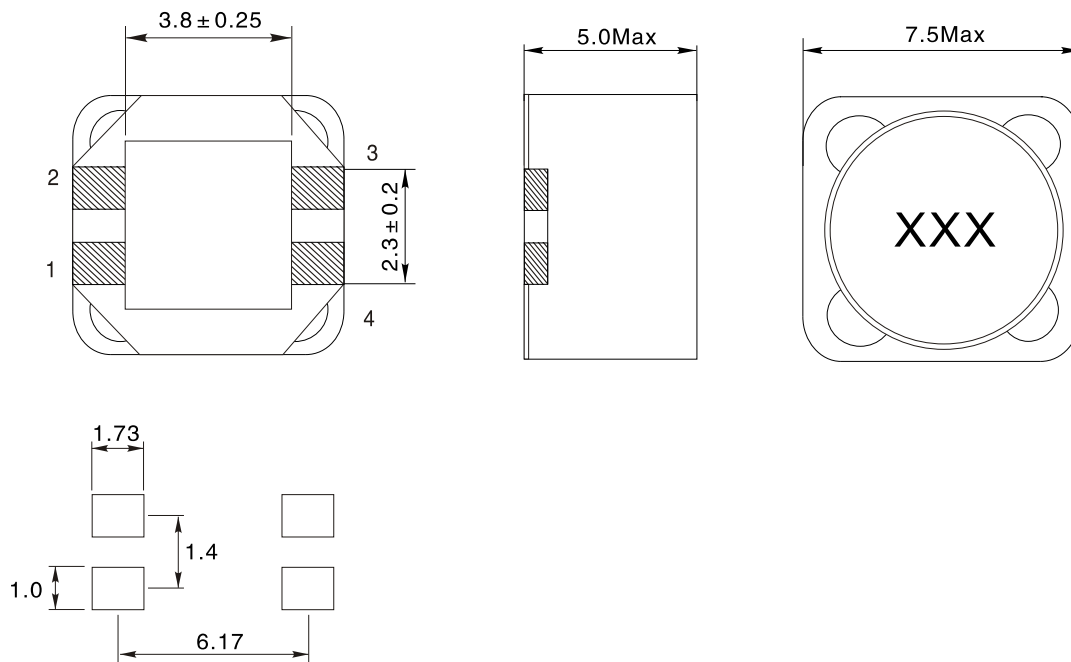

Recommended Land Pattern

### Notes:

1. 200Vac Isolation between windings
2. Storage temperature:  $-40^{\circ}\text{C}$  to  $+125^{\circ}\text{C}$
3. Operating temperature:  $-40^{\circ}\text{C}$  to  $+125^{\circ}\text{C}$  (range is application specific).
4. Solder reflow temperature:  $260^{\circ}\text{C}$  max. for 10 seconds max.
5. Turns Ratio (1:3):(2-4)=1:1
6. All specifications subject to change without notice.

# COUPLED INDUCTORS, COMMON MODE CHOKES SDRH1048D SERIES



## FEATURES:

- Only 4.8 mm high and 10.3 mm square
- AEC-Q200 Grade 1 (-40°C to +125°C)
- Ideal for use in both power line and signal line applications
- Common- and differential-mode filtering in a single device
- Up to 200 MHz differential mode cutoff frequency
- Can be used as coupled inductors for SEPIC applications
- RoHS compliant

## ELECTRICAL CHARACTERISTICS:

Partnumber	Common mode impedance Max (KΩ)	Cutoff frequency (MHz)	Inductance (μH)		DCR max (Ω)	Isolation (Vrms)	I <sub>rms</sub> (A)
			Min	Nom			
SDRH1048D-2R2N	3.49@71 MHz	200	1.54	2.2	0.019	200	2.4
SDRH1048D-100M	10.1@27 MHz	97	8.00	10	0.053	200	1.5
SDRH1048D-220M	17.0@17 MHz	44	17.6	22	0.098	200	1.3
SDRH1048D-470M	32.4 @12 MHz	29	37.6	47	0.208	200	1.1
SDRH1048D-680M	52.2 @9.3 MHz	38	54.4	68	0.297	200	1.0
SDRH1048D-101M	58.3 @7.4 MHz	19	80.0	100	0.387	200	0.85
SDRH1048D-221K	87.9 @5.0 MHz	16	198	220	0.840	200	0.62

## PHYSICAL CHARACTERISTICS & WINDING:

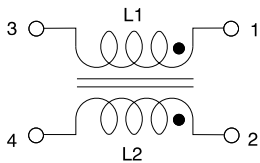
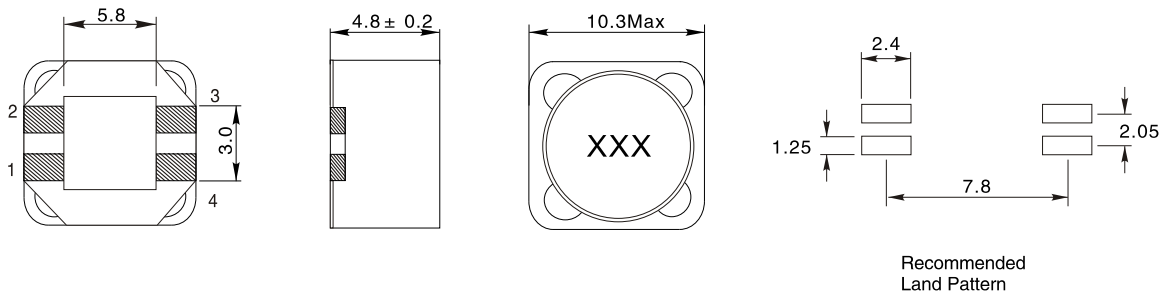

1. Frequency at which the differential mode attenuation equals -3dB
2. Inductance shown for each winding, measured at 100 kHz, 0.1 Vrms, 0 Adc on an Agilent/HP 4284A LCR meter or equivalent
3. DCR is for each winding.
4. Winding-to-winding isolation 500 Vrms, one minute
5. Current that causes a 40 °C temperature rise from 25 °C ambient. This information is for reference only and does not represent absolute maximum ratings
6. Electrical specifications at 25 °C
7. Ambient temperature -40 °C to +85 °C with I<sub>rms</sub> current. Maximum part temperature +125 °C (ambient + temp rise).
8. Storage temperature Component: -40 °C to +125 °C .
9. Tape and reel packaging: -40 °C to +80 °C

**PERFORMANCE CURVE:**

TYPICAL ATTENUATION (REF: 50 OHMS)

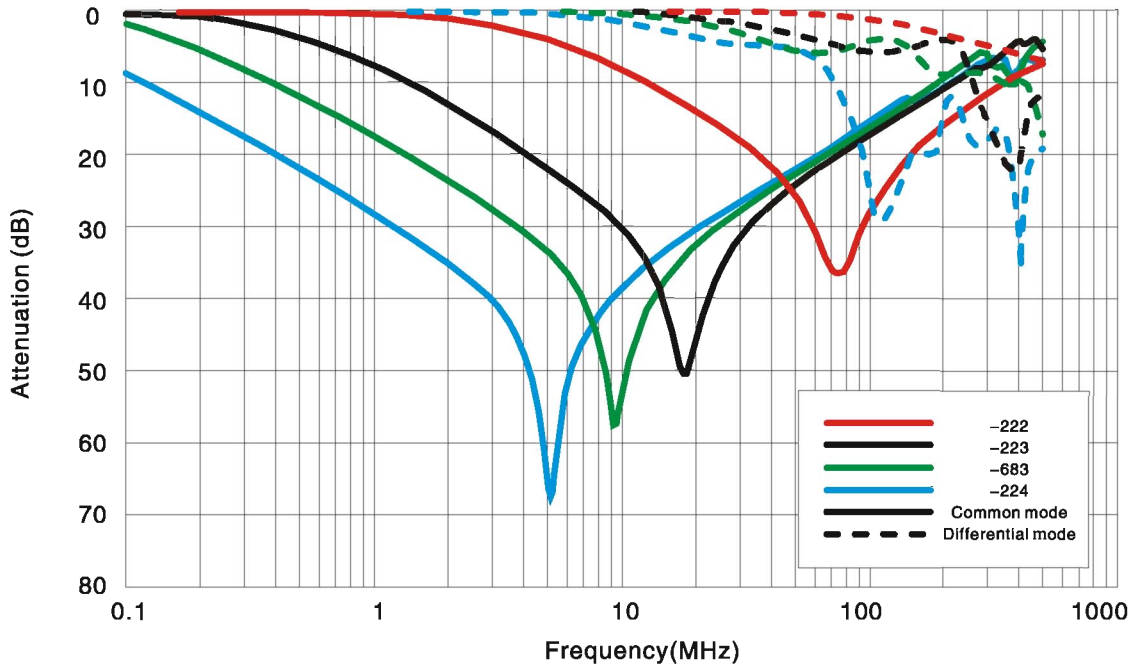

TYPICAL IMPEDANCE VS FREQUENCY

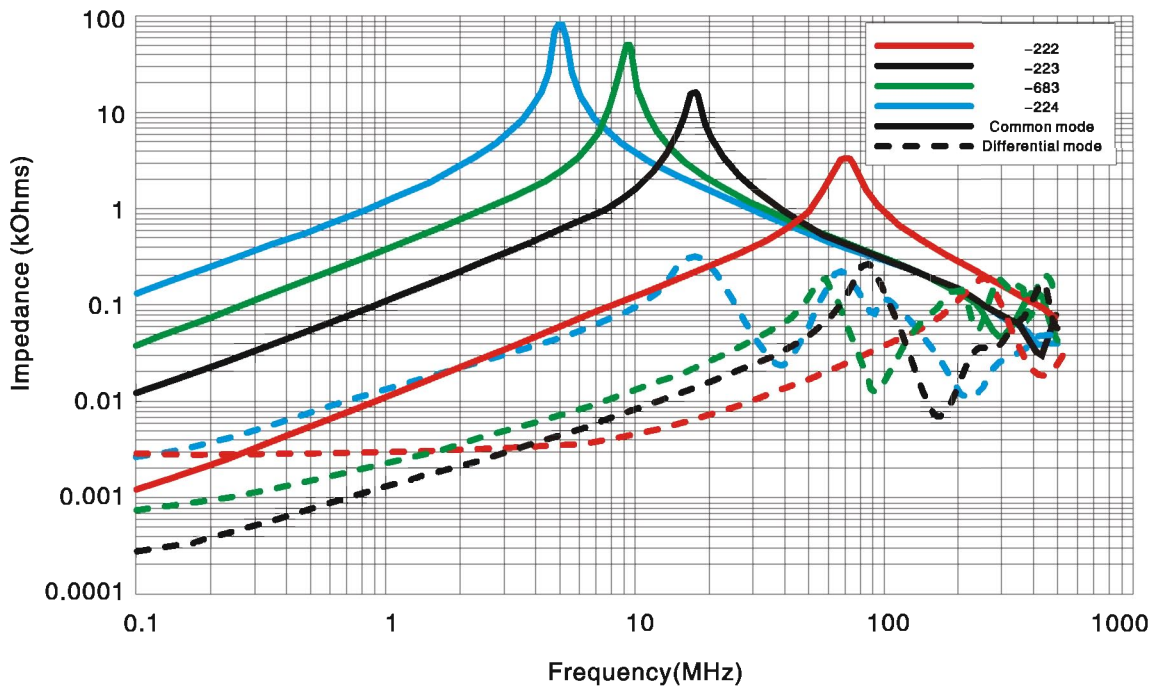

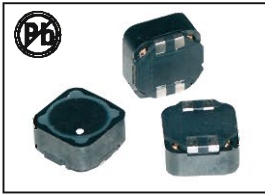

# DUAL WINDING, SHIELDING INDUCTORS

## SDRH1205D SERIES

### Description:

- Four sizes of shielded drum core inductors
- Windings can be connected in series or parallel offering a broadrange of inductance and current ratings
- Surface Mount

### Packaging:

- Supplied in tape and reel packaging 1350 (DRQ73), 1100 (DRQ74) 600 (DRQ125), and 350 (DRQ127) per reel

### Applications:

- As a transformer: SEPIC, flyback
- As an inductor: buck, boost, coupled inductor
- DC-DC converters
- VRM inductor for CPU and DDR power supplies
- Input and output filter chokes

## ELECTRICAL CHARACTERISTICS:

Part Number	Rated Inductance (uH)	Parallel ratings					Series ratings				
		OCL <sup>①</sup> ± 20% (uH)	I <sub>rms</sub> <sup>②</sup> (A)	I <sub>sat</sub> <sup>③</sup> (A)	DCR <sup>④</sup> (Ω)	Volt-sec <sup>⑤</sup>	OCL <sup>①</sup> ± 20% (uH)	I <sub>rms</sub> <sup>②</sup> (A)	I <sub>sat</sub> <sup>③</sup> (A)	DCR <sup>④</sup> (Ω)	Volt-sec <sup>⑤</sup>
SDRH1205D-R47M	0.47	0.456	17.6	33.0	0.0018	3.17	1.824	8.80	16.5	0.0078	6.34
SDRH1205D-1R0M	1.0	0.894	15.0	23.6	0.0024	4.43	3.576	7.51	11.8	0.0096	8.86
SDRH1205D-1R5M	1.5	1.478	13.8	18.3	0.0029	5.70	5.912	6.89	9.15	0.0114	11.40
SDRH1205D-2R2M	2.2	2.208	10.9	15.0	0.0045	6.97	8.832	5.46	7.50	0.0182	13.9
SDRH1205D-3R3M	3.3	3.084	9.26	12.7	0.0063	8.23	12.34	4.63	6.35	0.0253	16.5
SDRH1205D-4R7M	4.7	5.274	7.18	9.71	0.0105	10.8	21.10	3.59	4.86	0.0420	21.6
SDRH1205D-6R8M	6.8	6.588	6.64	8.68	0.0123	12.0	26.35	3.32	4.34	0.0492	24.0
SDRH1205D-8R2M	8.2	8.048	5.54	7.86	0.0176	13.3	32.19	2.77	3.93	0.0705	26.6
SDRH1205D-100M	10	9.654	5.35	7.17	0.0189	14.6	38.62	2.67	3.59	0.0757	29.2
SDRH1205D-150M	15	15.35	4.27	5.69	0.0298	18.4	61.40	2.13	2.85	0.0120	36.8
SDRH1205D-220M	22	22.36	3.70	4.71	0.0396	22.2	89.44	1.84	2.36	0.159	44.4
SDRH1205D-330M	33	33.74	3.28	3.84	0.0505	27.2	135.0	1.64	1.92	0.203	54.4
SDRH1205D-470M	47	47.47	2.71	3.24	0.0740	32.3	189.9	1.35	1.62	0.297	64.6
SDRH1205D-680M	68	67.91	2.22	2.70	0.101	38.6	271.6	1.11	1.35	0.440	77.2
SDRH1205D-820M	82	86.89	2.05	2.39	0.128	43.7	347.6	1.03	1.20	0.515	87.4
SDRH1205D-101M	100	102.7	1.78	2.20	0.170	47.5	410.8	0.892	1.10	0.682	95.0
SDRH1205D-151M	150	151.1	1.48	1.81	0.248	57.6	604.4	0.739	0.905	0.991	115.2
SDRH1205D-221M	220	216.8	1.19	1.51	0.384	69.0	867.2	0.594	0.755	1.54	138
SDRH1205D-331M	330	332.6	1.06	1.22	0.482	85.5	1330	0.530	0.610	1.93	171
SDRH1205D-471M	470	473.1	0.87	1.02	0.718	102	1892	0.434	0.510	2.87	204
SDRH1205D-681M	680	679.8	0.70	0.85	1.10	122	2719	0.350	0.425	4.42	244
SDRH1205D-821M	820	828.0	0.60	0.77	1.49	135	3312	0.301	0.385	5.96	270
SDRH1205D-102M	1000	1008	0.57	0.70	1.69	149	4032	0.283	0.350	6.76	298

- 1) Open Circuit Inductance Test Parameters: 100kHz, 0.25 Vrms, 0.0 Adc Parallel: (1, 2 - 4, 3) Series: (1-4) tie (2-3)
- 2) RMS current for an approximate DT of 40°C without core loss. It is recommended that the temperature of the part not exceed 125°C.
- 3) Peak current for approximately 30% roll-off at 20°C
- 4) DCR limits @ 20°C
- 5) Applied Volt-Time product (V-μS) across the inductor. This value represents the applied V-μ Sat 100KHz necessary to generate a core loss equal to 10% of the total losses for a 40° C temperature rise.

## SCHEMATIC

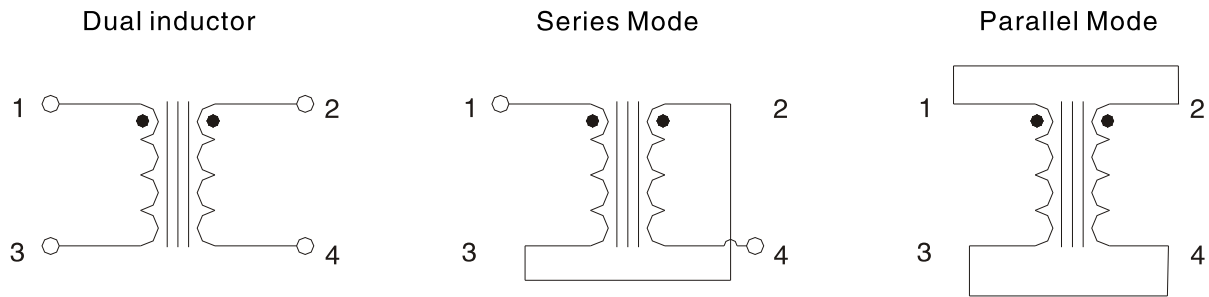

## PHYSICAL CHARACTERISTICS(Dimensions:mm)

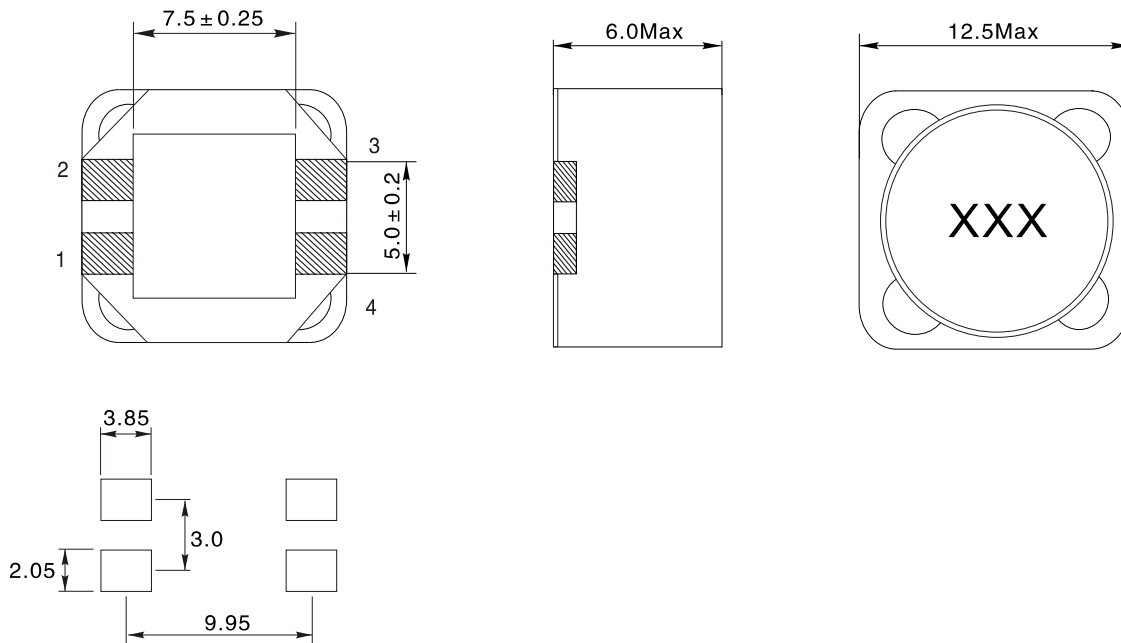

Recommended Land Pattern

### Notes:

1. 200Vac Isolation between windings
2. Storage temperature:  $-40^{\circ}\text{C}$  to  $+125^{\circ}\text{C}$
3. Operating temperature:  $-40^{\circ}\text{C}$  to  $+125^{\circ}\text{C}$  (range is application specific).
4. Solderreflow temperature:  $260^{\circ}\text{C}$  max. for 10 seconds max.
5. Turns Ratio (1:3):(2-4)=1:1
6. All specifications subject to change without notice.

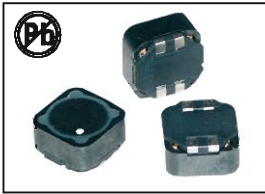

# DUAL WINDING, SHIELDING INDUCTORS

## SDRH1207D SERIES

### Description:

- Four sizes of shielded drum core inductors
- Windings can be connected in series or parallel offering a broadrange of inductance and current ratings
- Surface Mount

### Packaging:

- Supplied in tape and reel packaging 1350 (DRQ73), 1100 (DRQ74) 600 (DRQ125), and 350 (DRQ127) per reel

### Applications:

- As a transformer: SEPIC, flyback
- As an inductor: buck, boost, coupled inductor
- DC-DC converters
- VRM inductor for CPU and DDR power supplies
- Input and output filter chokes

## ELECTRICAL CHARACTERISTICS:

Part Number	Rated Inductance (uH)	Parallel ratings					Series ratings				
		OCL <sup>①</sup> ± 20% (uH)	I <sub>rms</sub> <sup>②</sup> (A)	I <sub>sat</sub> <sup>③</sup> (A)	DCR <sup>④</sup> (Ω)	Volt <sup>⑤</sup> u-sec	OCL <sup>①</sup> ± 20% (uH)	I <sub>rms</sub> <sup>②</sup> (A)	I <sub>sat</sub> <sup>③</sup> (A)	DCR <sup>④</sup> (Ω)	Volt <sup>⑤</sup> u-sec
SDRH1207D-R47M	0.47	0.419	17.9	56.0	0.00195	3.50	1.676	8.94	28	0.0078	7.00
SDRH1207D-1R0M	1.0	0.821	15.5	40.0	0.00281	4.90	3.284	7.74	20	0.0104	9.80
SDRH1207D-1R5M	1.5	1.357	13.5	31.1	0.00341	6.30	5.428	6.77	15.6	0.0137	12.80
SDRH1207D-2R2M	2.2	2.027	12.5	25.5	0.00373	7.70	8.108	6.23	12.7	0.0161	15.4
SDRH1207D-3R3M	3.3	2.831	10.4	21.5	0.00567	9.10	11.32	5.23	10.8	0.0229	18.2
SDRH1207D-4R7M	4.7	4.841	8.25	16.5	0.00917	11.9	19.36	4.13	8.24	0.0367	23.8
SDRH1207D-6R8M	6.8	7.387	7.34	13.3	0.0116	14.7	29.55	3.67	6.67	0.0465	29.4
SDRH1207D-8R2M	8.2	8.861	6.32	12.2	0.0157	16.1	35.44	3.16	6.09	0.0627	32.2
SDRH1207D-100M	10	10.47	6.04	11.2	0.0172	17.5	41.88	3.02	5.60	0.0686	35.0
SDRH1207D-150M	15	14.09	5.03	9.66	0.0247	20.3	58.36	2.51	4.83	0.0990	40.6
SDRH1207D-220M	22	22.93	4.00	7.57	0.0391	25.9	91.72	2.00	3.78	0.157	51.8
SDRH1207D-330M	33	33.92	3.23	6.22	0.0600	31.5	135.7	1.61	3.11	0.241	63.0
SDRH1207D-470M	47	47.05	2.95	5.28	0.0719	37.1	188.2	1.47	2.64	0.288	74.2
SDRH1207D-680M	68	66.48	2.44	4.44	0.105	44.1	265.9	1.22	2.22	0.421	88.2
SDRH1207D-820M	82	79.75	2.09	4.06	0.143	48.3	319.0	1.04	2.03	0.573	96.6
SDRH1207D-101M	100	99.31	1.96	3.64	0.163	53.9	397.2	0.980	1.82	0.653	107.8
SDRH1207D-151M	150	144.9	1.59	3.01	0.247	65.1	579.6	0.796	1.51	0.989	130.2
SDRH1207D-221M	220	221.5	1.29	2.43	0.376	80.5	886.0	0.645	1.22	1.50	161
SDRH1207D-331M	330	323.6	1.04	2.01	0.574	97.3	1294	0.522	1.01	2.30	195
SDRH1207D-471M	470	467.1	0.85	1.68	0.861	117	1868	0.427	0.838	3.44	234
SDRH1207D-681M	680	676.7	0.76	1.39	1.08	141	2707	0.380	0.697	4.32	282
SDRH1207D-821M	820	818.1	0.65	1.27	1.47	155	3272	0.325	0.633	5.88	310
SDRH1207D-102M	1000	1005	0.61	1.14	1.66	172	4020	0.307	0.571	6.64	344

- 1) Open Circuit Inductance Test Parameters: 100kHz, 0.25 Vrms, 0.0 Adc Parallel: (1, 2 - 4, 3) Series: (1-4) tie (2-3)
- 2) RMS current for an approximate DT of 40°C without core loss. It is recommended that the temperature of the part not exceed 125°C.
- 3) Peak current for approximately 30% roll-off at 20°C
- 4) DCR limits @ 20°C
- 5) Applied Volt-Time product (V-μS) across the inductor. This value represents the applied V-μ Sat 100KHz necessary to generate a core loss equal to 10% of the total losses for a 40° C temperature rise.

## SCHEMATIC

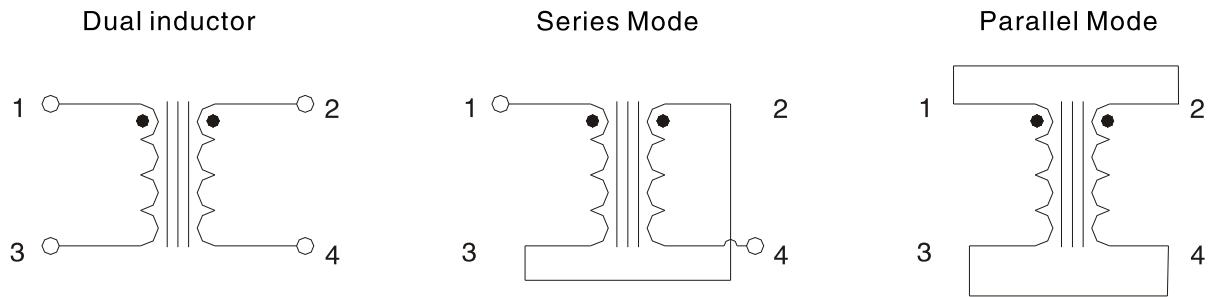

## PHYSICAL CHARACTERISTICS(Dimensions:mm)

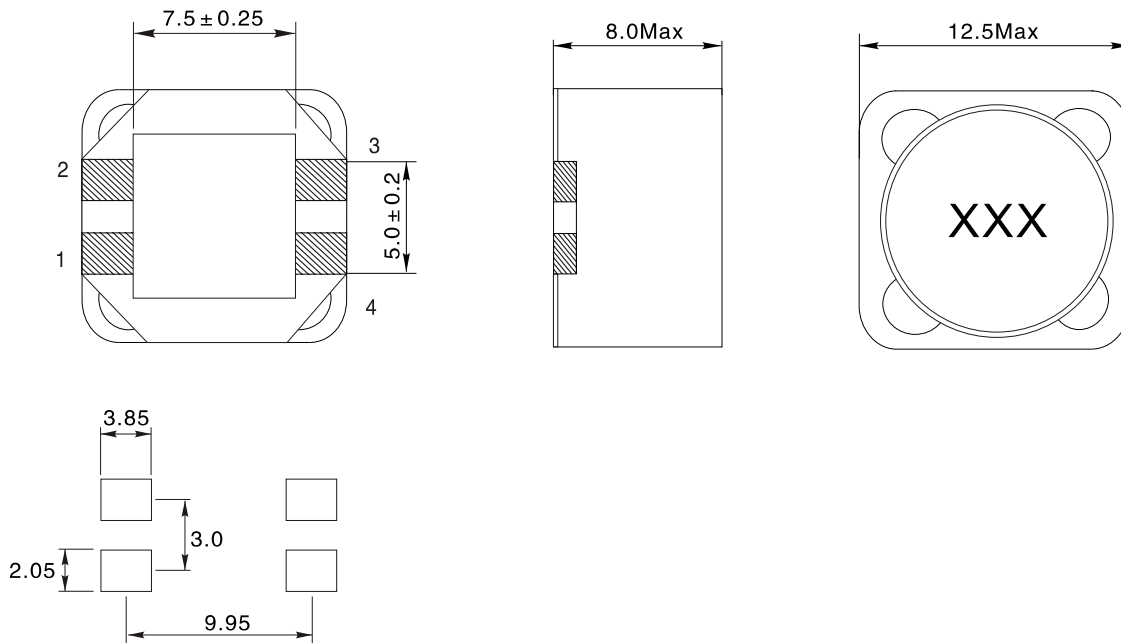

Recommended Land Pattern

### Notes:

1. 200Vac Isolation between windings
2. Storage temperature:  $-40^{\circ}\text{C}$  to  $+125^{\circ}\text{C}$
3. Operating temperature:  $-40^{\circ}\text{C}$  to  $+125^{\circ}\text{C}$  (range is application specific).
4. Solderreflow temperature:  $260^{\circ}\text{C}$  max. for 10 seconds max.
5. Turns Ratio (1:3):(2-4)=1:1
6. All specifications subject to change without notice.

# COUPLED INDUCTORS, COMMON MODE CHOKES

## SDRH1260D SERIES



### FEATURES:

- Only 6.0 mm high and 12.3 mm square
- AEC-Q200 Grade 1 (-40°C to +125°C)
- Ideal for use in both power line and signal line applications
- Common- and differential-mode filtering in a single device
- Up to 180 MHz differential mode cutoff frequency
- Can be used as coupled inductors for SEPIC applications
- RoHS compliant

### ELECTRICAL CHARACTERISTICS:

Partnumber	Common mode impedance Max (KΩ)	Cutoff frequency (MHz)	Inductance (μH)		DCR max (Ω)	Isolation (Vrms)	I <sub>rms</sub> (A)
			Min	Nom			
SDRH1260D-3R3Y	5.29@53 MHz	170	2.64	3.3	0.020	500	3.60
SDRH1260D-4R7Y	6.27@43 MHz	140	3.76	4.7	0.036	500	3.16
SDRH1260D-5R8Y	8.38@36 MHz	91	4.48	5.6	0.040	500	3.00
SDRH1260D-6R8Y	9.78@33 MHz	120	5.44	6.8	0.048	500	2.75
SDRH1260D-8R2	9.72@30 MHz	110	6.56	8.2	0.052	500	2.63
SDRH1260D-100Y	12.31@26 MHz	110	8.00	10	0.080	500	2.45
SDRH1260D-120Y	14.67@23 MHz	81	9.60	12	0.074	500	2.21
SDRH1260D-150Y	16.17@21 MHz	77	12.0	15	0.085	500	2.06
SDRH1260D-180Y	16.96@18 MHz	64	14.4	18	0.097	500	1.93
SDRH1260D-220Y	20.73@17 MHz	79	17.6	22	0.116	500	1.76
SDRH1260D-270Y	26.07@15 MHz	58	21.6	27	0.124	500	1.70
SDRH1260D-330	26.15@12 MHz	58	26.4	33	0.134	500	1.64
SDRH1260D-390Y	30.30@12 MHz	36	31.2	39	0.142	500	1.59
SDRH1260D-470Y	29.81@11 MHz	53	37.6	47	0.174	500	1.44
SDRH1260D-560Y	51.88@9.6 MHz	33	44.8	56	0.198	500	1.35
SDRH1260D-680Y	55.74@8.6 MHz	25	54.4	68	0.216	500	1.29
SDRH1260D-820Y	70.75@8.2 MHz	26	65.6	82	0.274	500	1.15
SDRH1260D-101Y	80.40@7.3 MHz	17	80.0	100	0.322	500	1.06
SDRH1260D-121Y	87.96@6.2 MHz	27	108	120	0.418	500	0.93
SDRH1260D-151Y	97.64@5.4 MHz	45	135	150	0.476	500	0.87
SDRH1260D-181Y	124.3@5.2 MHz	23	162	180	0.536	500	0.82
SDRH1260D-221Y	143.4@4.3 MHz	25	198	220	0.691	500	0.72
SDRH1260D-271Y	134.8@4.3 MHz	11	243	270	0.806	500	0.67
SDRH1260D-331Y	132.1@3.6 MHz	35	297	330	1.09	500	0.57
SDRH1260D-391Y	131.0@3.4 MHz	14	351	390	1.20	500	0.55
SDRH1260D-471Y	193.5@3.3 MHz	21	423	470	1.59	500	0.48
SDRH1260D-561Y	175.2@2.7 MHz	15	504	560	1.81	500	0.45
SDRH1260D-681Y	158.6@2.7 MHz	11	612	680	2.06	500	0.42
SDRH1260D-821Y	225.9@2.2 MHz	9.2	738	820	2.65	500	0.37
SDRH1260D-102Y	197.0@2.3 MHz	15	900	1000	3.06	500	0.34

## PHYSICAL CHARACTERISTICS & WINDING:

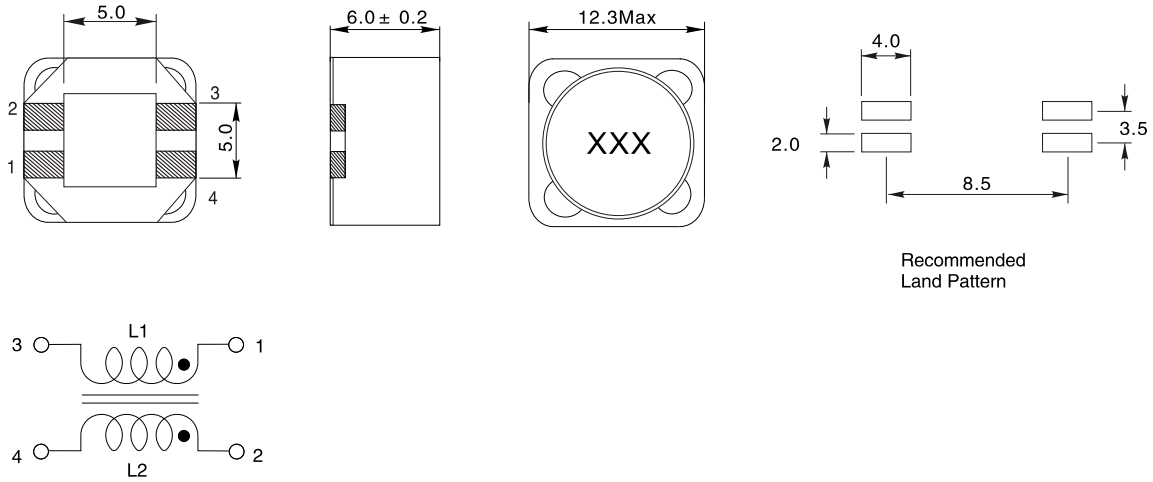

1. Frequency at which the differential mode attenuation equals  $-3\text{dB}$
2. Inductance shown for each winding, measured at 100 kHz, 0.1 Vrms, 0 Adc on an Agilent/HP 4284A LCR meter or equivalent
3. DCR is for each winding.
4. Winding-to-winding isolation 500 Vrms, one minute
5. Current that causes a 40 °C temperature rise from 25 °C ambient. This information is for reference only and does not represent absolute maximum ratings
6. Electrical specifications at 25 °C
7. Ambient temperature  $-40\text{ °C}$  to  $+125\text{ °C}$  with Irms current. Maximum part temperature  $+165\text{ °C}$  (ambient + temp rise).
8. Storage temperature Component:  $-40\text{ °C}$  to  $+165\text{ °C}$  .
9. Tape and reel packaging:  $-40\text{ °C}$  to  $+80\text{ °C}$

**PERFORMANCE CURVE:**

Typical Attenuation(Ref:50 Ohms)

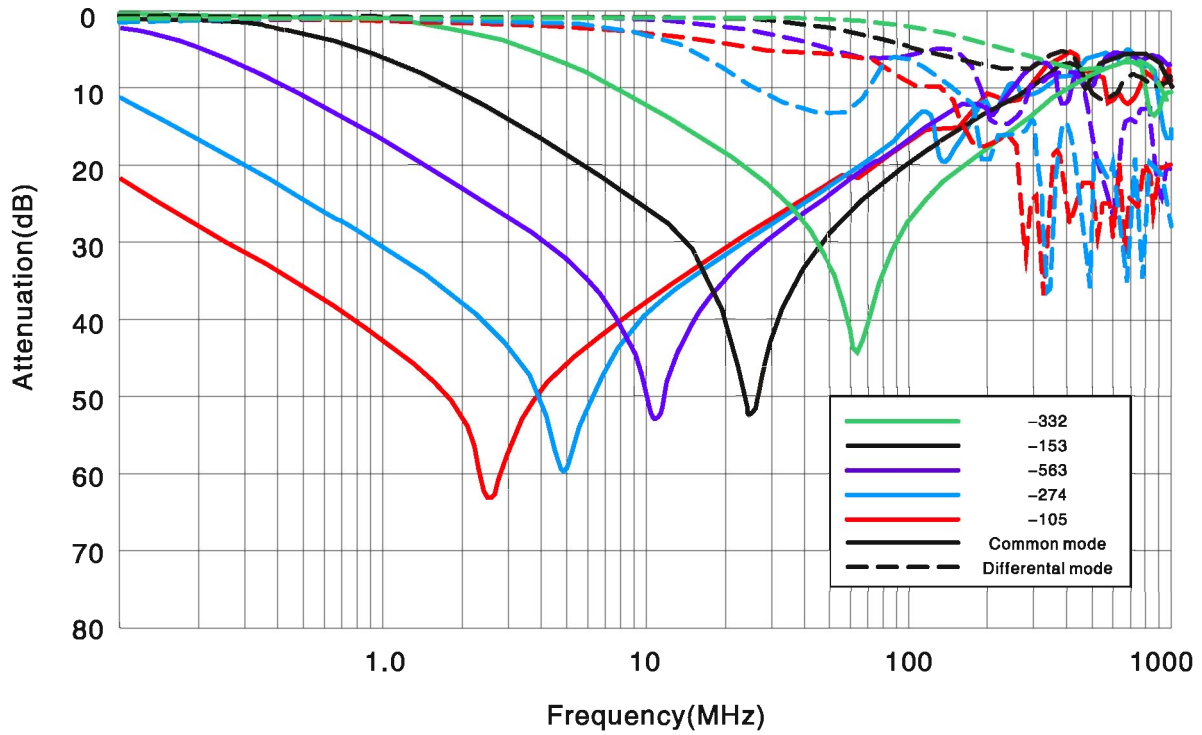

Typical Impedance vs Frequency

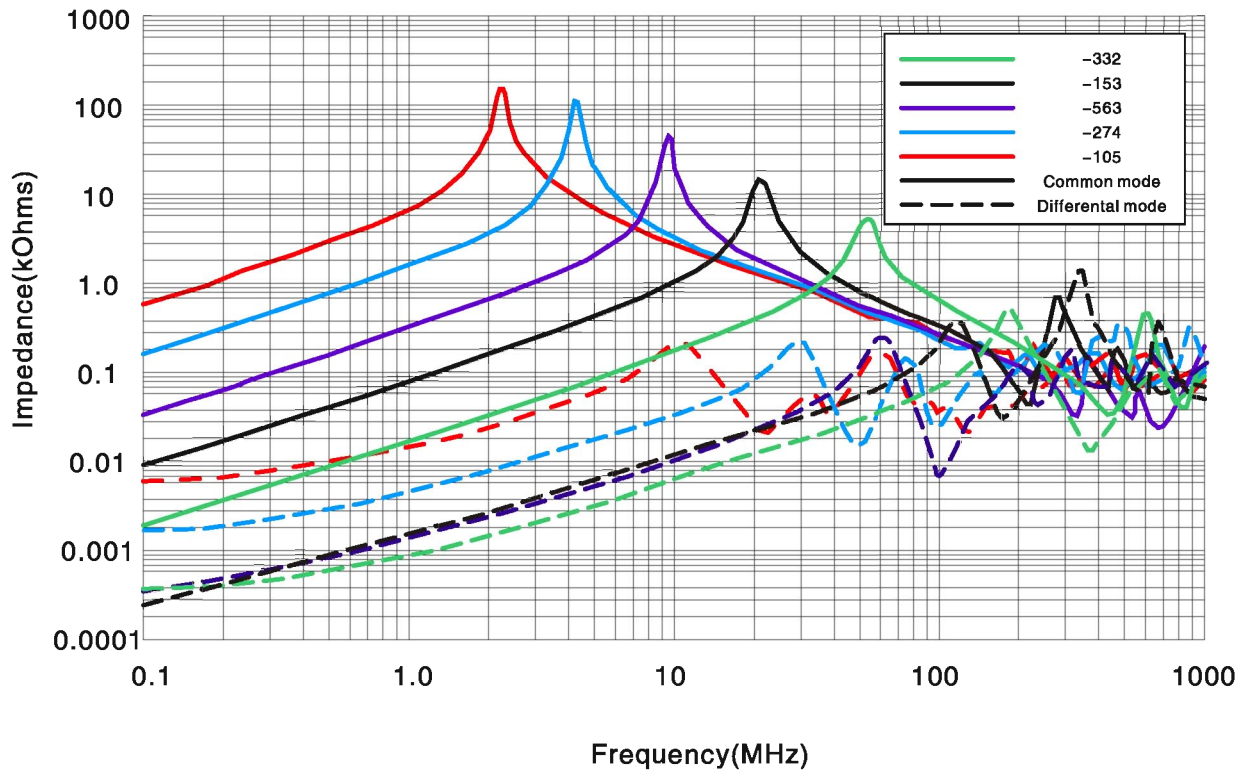

# COUPLED INDUCTORS, COMMON MODE CHOKES

## SDRH1278D SERIES



### FEATURES:

- Only 7.8 mm high and 12.3 mm square
- Ideal for use in flyback, multi-output buck, SEPIC and Zeta applications
- High inductance, high efficiency and excellent current handling
- Can also be used as two single inductors connected in series or parallel or as a common mode choke
- UL Certified per File E219568

### ELECTRICAL CHARACTERISTICS:

Part number SDRH1278D-	Inductance (uH)	DCR max (Ohms)	SRF typ (Mhz)	Coupling coefficient typ	Leakage L typ (uH)	Isat (A)			Irms (A)	
						10% drop	20% drop	30% drop	both windings	one windings
4R7M	4.7+20%	0.040	33.0	0.98	0.22	13.90	15.20	16.36	3.16	4.47
5R6M	5.6+20%	0.046	30.0	0.98	0.23	13.38	14.86	15.74	2.87	4.06
6R8M	6.8+20%	0.048	23.0	0.98	0.22	12.10	13.56	14.20	2.81	3.98
8R2M	8.2+20%	0.055	20.0	0.98	0.34	10.30	11.52	12.20	2.76	3.90
100M	10+20%	0.058	17.0	0.98	0.34	8.80	10.00	10.66	2.56	3.62
120M	12+20%	0.062	15.0	0.98	0.36	8.20	9.18	9.74	2.48	3.50
150M	15+20%	0.072	13.0	0.99	0.41	7.40	8.36	9.03	2.30	3.25
180M	18+20%	0.080	12.0	0.99	0.37	6.50	7.38	7.86	2.18	3.08
220M	22+20%	0.096	11.0	0.99	0.41	6.00	6.80	7.26	1.99	2.81
270M	27+20%	0.120	10.0	0.99	0.43	5.80	6.56	7.02	1.78	2.52
330M	33+20%	0.150	9.5	0.99	0.56	5.50	6.10	6.52	1.59	2.25
390M	39+20%	0.161	8.5	0.99	0.64	4.70	5.26	5.60	1.54	2.18
470M	47+20%	0.180	7.5	0.99	0.70	3.70	4.34	4.60	1.45	2.05
560M	56+20%	0.190	7.0	0.99	0.76	3.60	4.18	4.50	1.41	2.00
680M	68+20%	0.210	6.5	0.99	0.88	3.50	4.04	4.32	1.35	1.90
820M	82+20%	0.280	5.0	0.99	0.85	2.60	3.72	4.02	1.16	1.65
101M	100+20%	0.300	4.5	> 0.99	0.90	2.20	3.24	3.46	1.13	1.59
121K	120+10%	0.410	4.3	0.99	1.31	2.10	2.94	3.16	0.96	1.36
151K	150+10%	0.460	4.1	> 0.99	1.46	3.30	2.54	2.70	0.91	1.29
181K	180+10%	0.510	4.0	> 0.99	0.93	2.80	2.42	2.58	0.86	1.22
221K	220+10%	0.690	3.4	> 0.99	1.54	1.90	2.16	2.28	0.74	1.05
271K	270+10%	0.900	3.1	> 0.99	1.17	1.70	1.94	2.10	0.65	0.92
331K	330+10%	1.02	2.9	0.99	4.14	1.50	1.70	1.84	0.61	0.86
391K	390+10%	1.12	2.7	> 0.99	1.64	1.40	1.60	1.70	0.58	0.82
471K	470+10%	1.53	2.2	> 0.99	0.25	1.30	1.50	1.60	0.50	0.70
561K	560+10%	1.69	2.0	> 0.99	2.68	1.20	1.34	1.48	0.47	0.67
681K	680+10%	2.29	1.7	> 0.99	2.11	1.00	1.08	1.22	0.41	0.58
821K	820+10%	2.55	1.4	> 0.99	2.39	0.900	1.04	1.18	0.39	0.55
102K	1000+10%	2.87	1.3	> 0.99	4.28	0.850	0.948	1.05	0.37	0.52

1. Inductance shown for each winding, measured at 100 kHz, 0.1 Vrms, 0 Adc on an Agilent/HP 4284A LCR meter or equivalent. When leads are connected in parallel, inductance is the same value. When leads are connected in series, inductance is four times the value
2. DCR is for each winding. When leads are connected in parallel, DCR is half the value. When leads are connected in series, DCR is twice the value
3. SRF measured using an Agilent/HP 4191A or equivalent. When leads are connected in parallel, SRF is the same value
4. Leakage Inductance is for L1 and is measured with L2 shorted
5. DC current at 25 °C that causes the specified inductance drop from its value without current. It is the sum of the current flowing in both windings
6. Equal current when applied to each winding simultaneously that causes a 40 °C temperature rise from 25 °C ambient. This information is for reference only and does not represent absolute maximum ratings
7. Maximum current when applied to one winding that causes a 40 °C temperature rise from 25 °C ambient. This information is for reference only and does not represent absolute maximum ratings
8. Electrical specifications at 25 °C
9. Ambient temperature -40 °C to +125 °C with (40 °C rise) I rms current
10. Maximum part temperature +165 °C (ambient + temp rise)
11. Storage temperature Component: -40 °C to +165 °C
12. Tape and reel packaging: -40 °C to +80 °C
13. Winding to winding isolation 100 Vrms, one minute
14. Resistance to soldering heat Max three 40 second reflows at +260 °C , parts cooled to room temperature between cycles
15. Packaging 1000/7" reel; 3500/13" reel

**PHYSICAL CHARACTERISTICS & WINDING:**

Dimensions are in mm

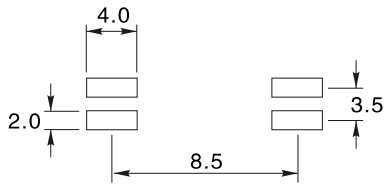
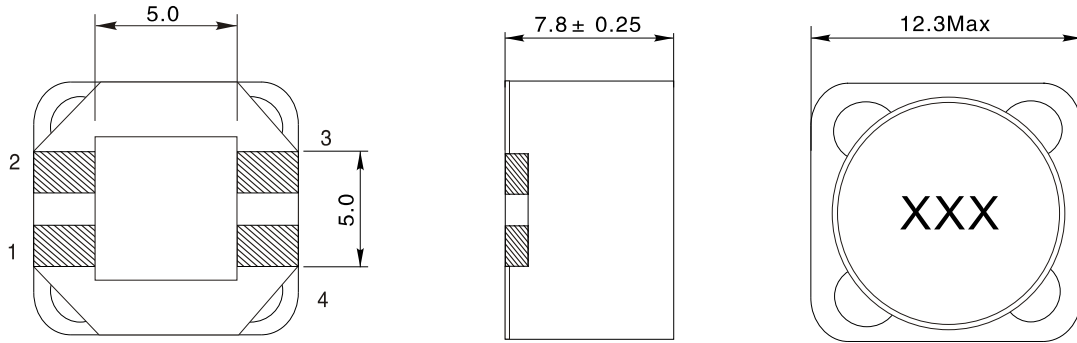

Recommended Land Pattern

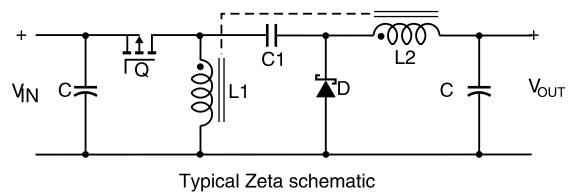
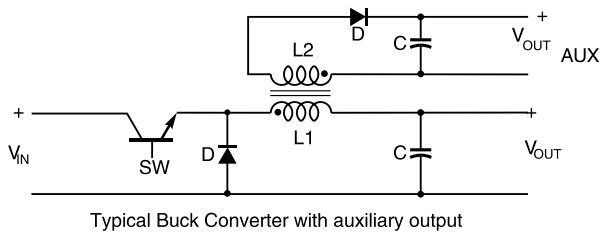
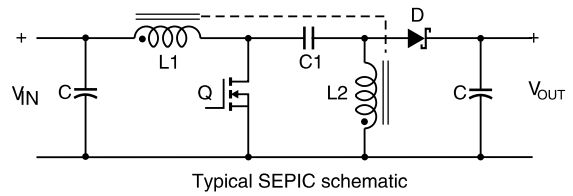
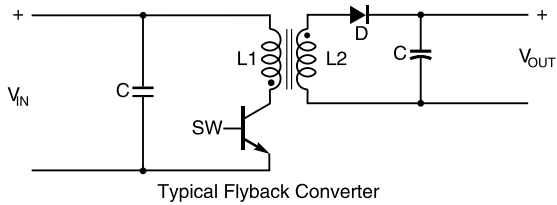
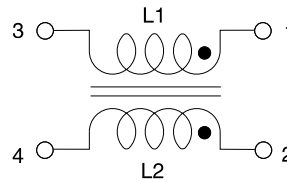

# PERFORMANCE CURVE:

TYPICAL L VS CURRENT

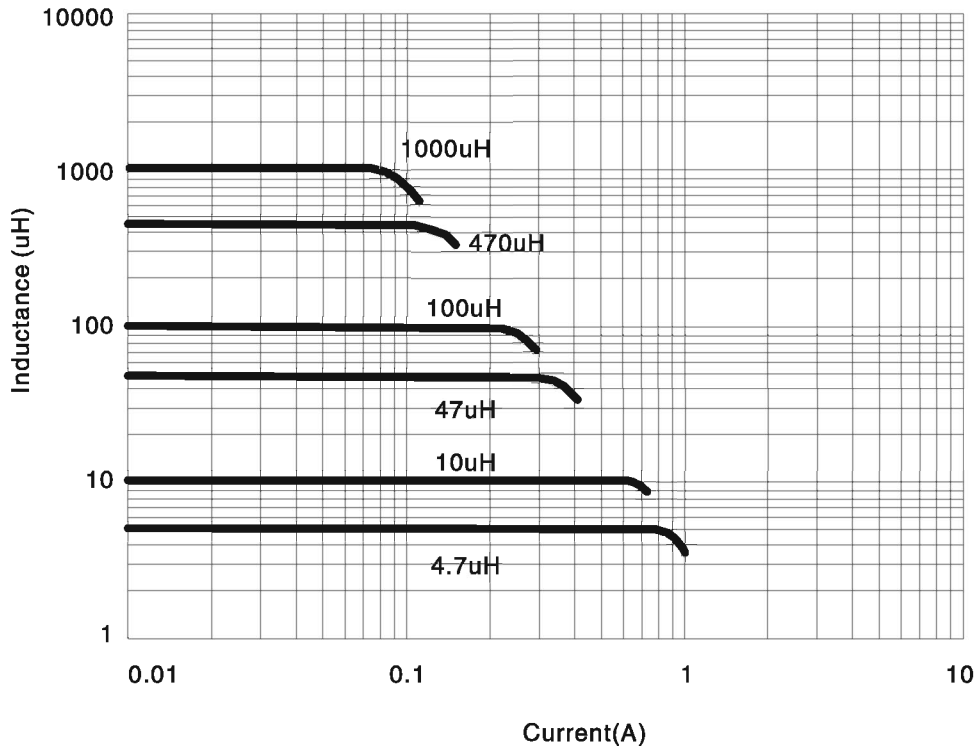

TYPICAL L VS FREQUENCY

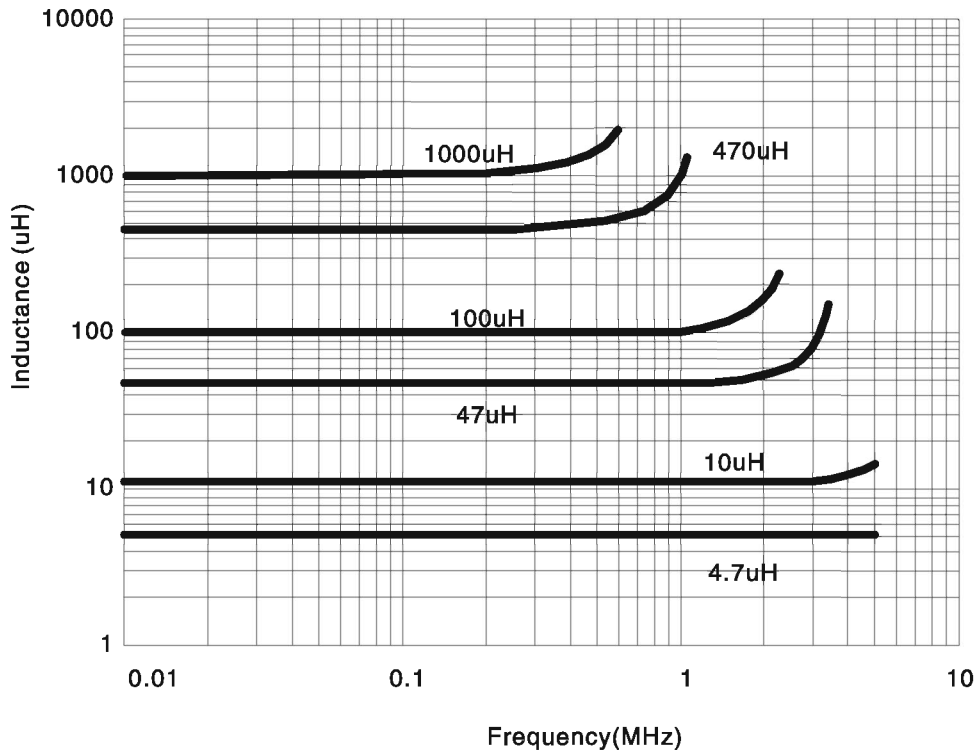

# COMMON MODE CHOKE, COUPLED INDUCTOR SDRH1514D SERIES



## FEATURES:

- Low DCR, high rated current.
- Magnetic shielded structure
- Lead free product, RoHS compliant.
- Carrier tape packing, suitable for SMT process.

## APPLICATIONS:

- Widely used in buck converter, laptop, display, network communication equipment, and etc.

## ELECTRICAL CHARACTERISTICS@25°C

Part Number	Inductance (uH)	DCR (mΩ)Max	Leakage inductance (uH)Typ.	Saturation current(A)			Temperature rise current(A)	
				10%drop	20%drop	30%drop	Both windings	One winding
SDRH1514D-220M	22.0 ± 20%	36.0	0.45	9.1	9.6	10.2	3.8	5.4
SDRH1514D-270M	27.0 ± 20%	39.0	0.45	9.0	9.6	10.2	3.3	4.7
SDRH1514D-330M	33.0 ± 20%	42.0	0.45	7.4	8.2	9.0	3.2	4.5
SDRH1514D-470M	47.0 ± 20%	54.0	0.55	5.8	6.6	6.75	3.05	4.31
SDRH1514D-680M	68.0 ± 20%	65.0	0.55	5.3	5.7	5.9	2.72	3.64
SDRH1514D-101M	100 ± 10%	93.0	0.55	4.35	4.75	4.95	2.08	2.94
SDRH1514D-221M	220 ± 10%	172.0	0.7	2.95	3.2	3.3	1.61	2.27
SDRH1514D-331M	330 ± 10%	258.0	0.8	2.55	2.65	2.78	1.32	1.86
SDRH1514D-471M	470 ± 10%	382.0	1.2	2.0	2.2	2.3	1.03	1.46
SDRH1514D-102M	1000 ± 10%	786.0	2.0	1.45	1.55	1.6	0.78	1.1

## TECHNICAL INFORMATION & PHYSICAL CHARACTERISTICS

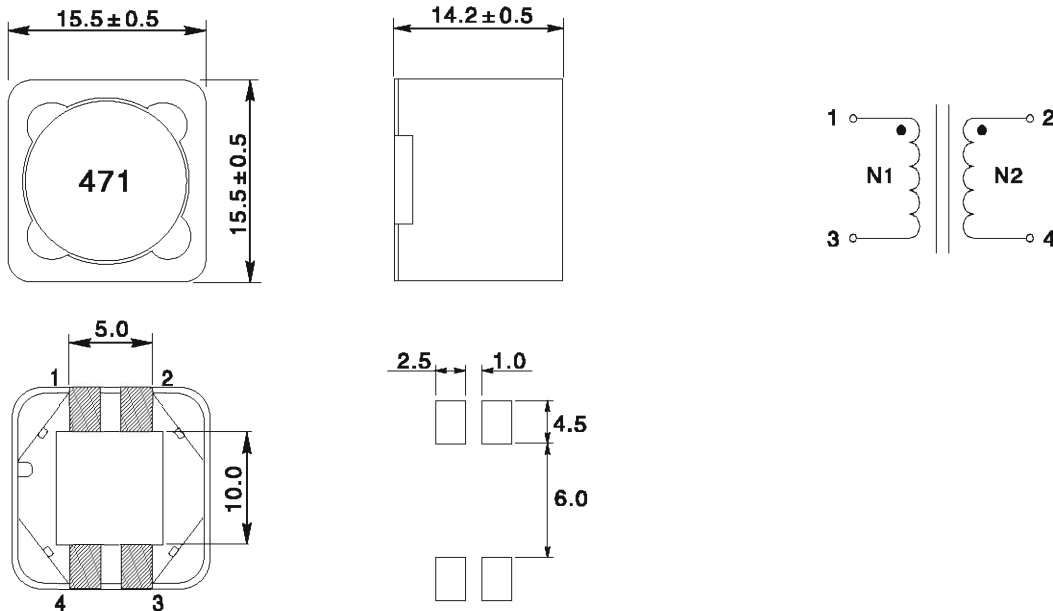

- All data is tested based on 25°C ambient temperature
- Inductance measure condition at 100kHz, 0.1V
- Leakage inductance is for N1 and is measured with N2 shorted
- Saturation current: the actual value of DC current when the inductance decrease corresponding percentage of its initial value
- Temperature rise current: the actual value of DC current when the temperature rise is ΔT40°C(Ta=25°C)
- Operating temperature: -40°C to +125°C(Including self temperature rise)
- Special remind: Circuit design, component placement, PCB size and thickness, cooling system and etc. all will affect the product temperature. Please verify the product temperature in the final application.

# COMMON MODE CHOKE, COUPLED INDUCTOR SDRH1514D SERIES



## SATURATION CURRENT VS TEMPERATURE RISE CURRENT CURVE

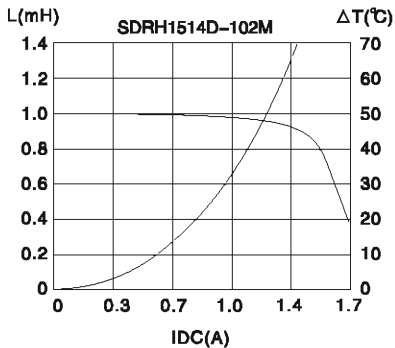
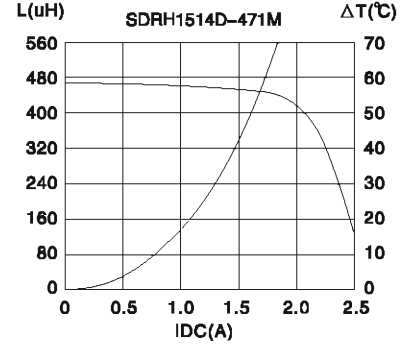
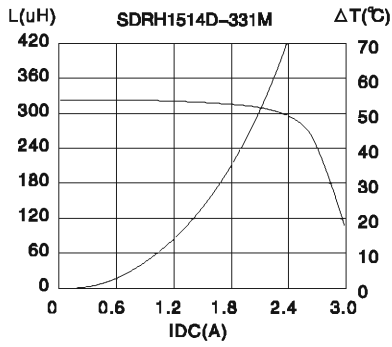
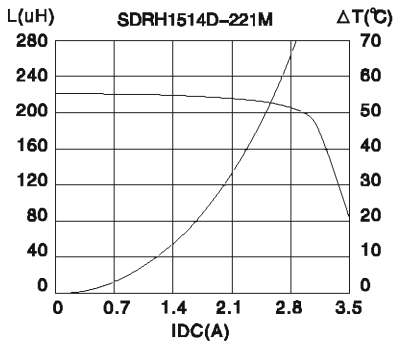
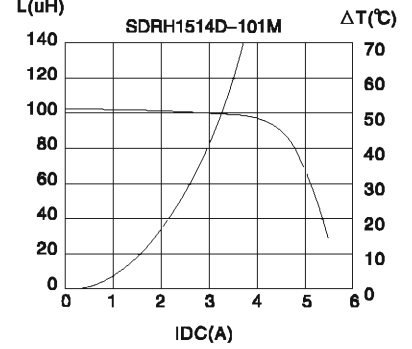
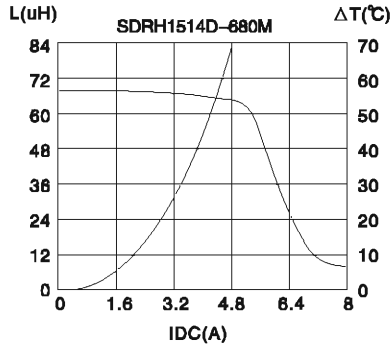
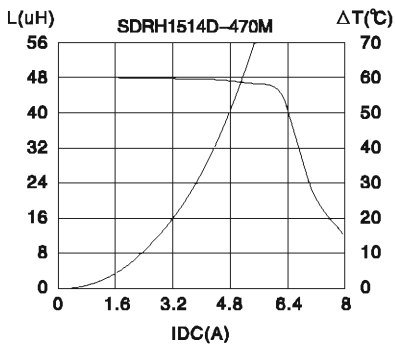
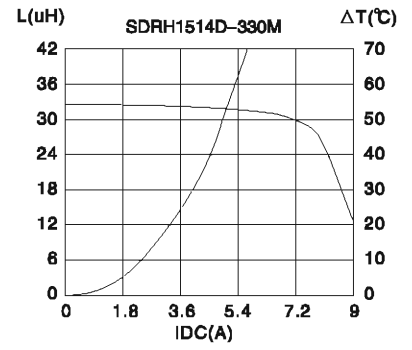
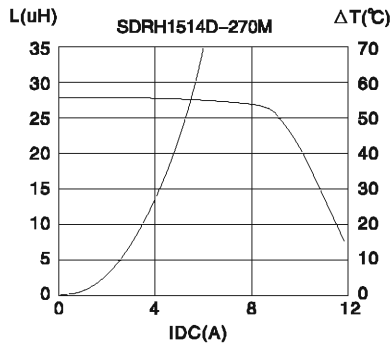
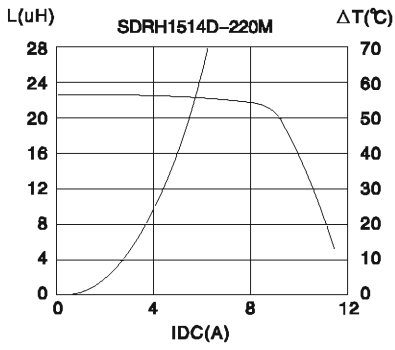

# COUPLED INDUCTORS, COMMON MODE CHOKES SDRH1583D SERIES



## FEATURES:

- Ideal for use in both power line and signal line applications
- Common- and differential-mode filtering in a single device
- Up to 38 MHz differential mode cutoff frequency
- Can be used as coupled inductors for SEPIC applications
- RoHS compliant

## ELECTRICAL CHARACTERISTICS:

Partnumber	Common mode impedance Max (K $\Omega$ )	Cutoff frequency (MHz)	Inductance ( $\mu$ H)		DCR max ( $\Omega$ )	Isolation (Vrms)	I <sub>rms</sub> (A)
			Min	Nom			
SDRH1583D-100M	10.86 @ 17 MHz	38	8.0	10	0.031	500	3.68
SDRH1583D-120M	12.11 @ 16 MHz	30	9.6	12	0.037	500	3.54
SDRH1583D-150M	12.31 @ 14 MHz	25	12.0	15	0.045	500	3.18
SDRH1583D-180M	15.77 @ 13 MHz	25	14.4	18	0.048	500	3.04
SDRH1583D-220M	14.47 @ 12 MHz	28	17.6	22	0.065	500	2.44
SDRH1583D-330M	33.82 @ 9 MHz	28	26.4	33	0.095	500	2.16
SDRH1583D-470M	39.79 @ 7.6 Mhz	23	37.6	47	0.115	500	1.98
SDRH1583D-680M	49.24 @ 5.9 MHz	17	54.4	68	0.165	500	1.56
SDRH1583D-101K	69.83 @ 5 MHz	16	90.0	100	0.260	500	1.24
SDRH1583D-151K	73.09 @ 3.9 MHz	12	135	150	0.380	500	1.06
SDRH1583D-221K	78.91 @ 3.3 MHz	9.7	198	220	0.460	500	0.92
SDRH1583D-471K	104.9 @ 2.2 MHz	7.4	423	470	1.04	500	0.65
SDRH1583D-102K	129.0 @ 1.5 MHz	5.8	900	1000	2.40	500	0.42

## PHYSICAL CHARACTERISTICS & WINDING:

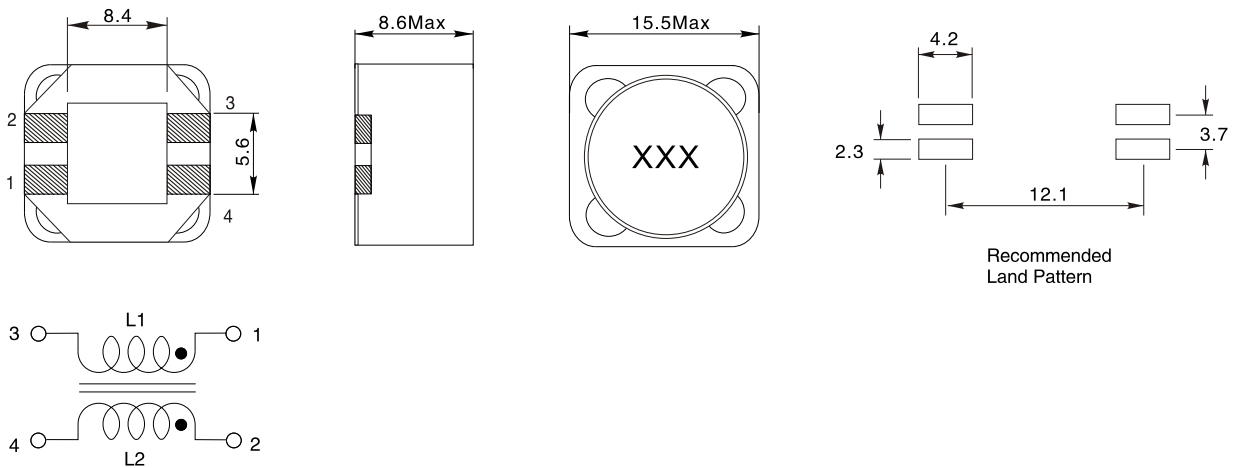

1. Frequency at which the differential mode attenuation equals 3dB
2. Inductance shown for each winding, measured at 100 kHz, 0.1 Vrms, 0 Adc on an Agilent/HP 4284A LCR meter or equivalent
3. DCR is for each winding.
4. Winding-to-winding isolation 500 Vrms, one minute
5. Current that causes a 40 °C temperature rise from 25 °C ambient. This information is for reference only and does not represent absolute maximum ratings
6. Electrical specifications at 25 °C
7. Ambient temperature -40 °C to +85 °C with I<sub>rms</sub> current. Maximum part temperature +125 °C (ambient + temp rise).
8. Storage temperature Component: -40 °C to +125 °C .
9. Tape and reel packaging: -40 °C to +80 °C

**PERFORMANCE CURVE:**

TYPICAL ATTENUATION (REF: 50 OHMS)

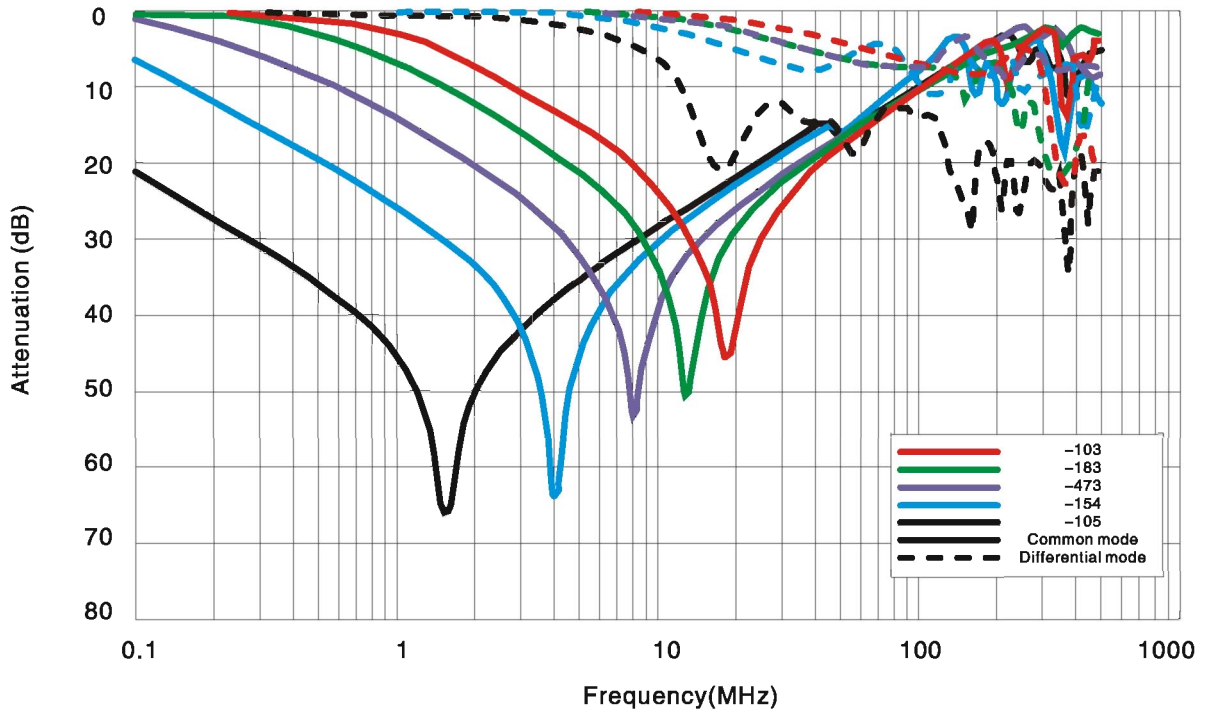

TYPICAL IMPEDANCE VS FREQUENCY

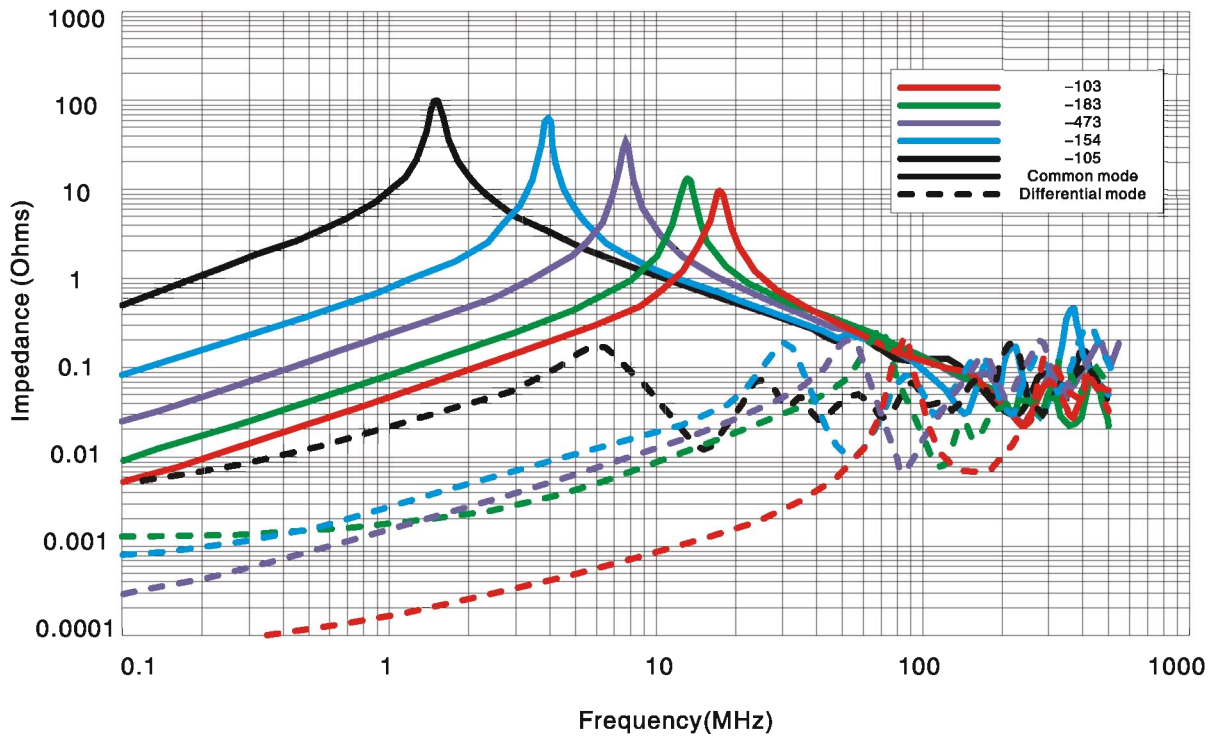

# COUPLED INDUCTORS, COMMON MODE CHOKES

## SDRH3015D SERIES

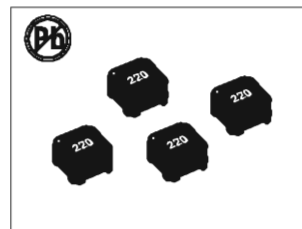

### FEATURES:

- Only 1.4 mm high and 3 mm square
- Ideal for use in flyback, multi-output buck, SEPIC and Zeta applications
- High inductance, high efficiency and excellent current handling
- Can also be used as two single inductors connected in series or parallel or as a common mode choke
- UL Certified per File E219588

### ELECTRICAL CHARACTERISTICS:

Part number SDRH3015D-	Inductance ± 20% (uH)	DCR max (Ohms)	SRF typ (Mhz)	Coupling coefficient typ	Leakage L typ (uH)	Isat (A)			Irms (A)	
						10% drop	20% drop	30% drop	both windings	one windings
R39M	0.39	0.071	289	0.89	0.08	3.2	3.3	3.4	1.45	2.05
R56M	0.56	0.079	235	0.93	0.08	2.7	2.8	2.8	1.37	1.94
1R0M	1.0	0.129	160	0.95	0.09	2.0	2.1	2.2	1.08	1.52
1R5M	1.5	0.204	140	0.96	0.11	1.6	1.7	1.8	0.86	1.20
1R8M	1.8	0.273	135	0.96	0.13	1.5	1.6	1.6	0.78	1.10
2R2M	2.2	0.300	110	0.97	0.14	1.5	1.6	1.6	0.75	1.05
3R3M	3.3	0.337	90	0.98	0.16	1.0	1.1	1.2	0.67	0.94
4R7M	4.7	0.503	79	0.98	0.18	0.86	0.87	0.88	0.54	0.76
6R8M	6.8	0.622	58	0.98	0.22	0.77	0.78	0.79	0.49	0.69
100M	10	1.040	48	0.99	0.28	0.58	0.59	0.60	0.38	0.53
150M	15	1.420	35	0.99	0.37	0.49	0.50	0.51	0.32	0.46
180M	18	1.550	33	0.99	0.42	0.46	0.47	0.48	0.31	0.44
220M	22	1.89	30	0.99	0.48	0.42	0.43	0.44	0.28	0.40
330M	33	2.84	23	0.99	0.63	0.34	0.35	0.36	0.23	0.32
470M	47	4.03	17	0.99	0.81	0.28	0.29	0.30	0.19	0.27
680M	68	6.11	14	0.99	1.13	0.24	0.25	0.26	0.16	0.22
101M	100	8.54	11	0.99	1.50	0.20	0.21	0.22	0.13	0.19
121M	120	9.23	9.0	0.99	1.76	0.19	0.20	0.20	0.13	0.18
151M	150	12.40	8.0	0.99	2.22	0.16	0.17	0.18	0.11	0.16
181M	180	15.32	7.5	0.99	2.79	0.15	0.16	0.17	0.10	0.14
221M	220	18.56	6.0	0.99	3.56	0.13	0.14	0.15	0.09	0.13
331M	330	27.70	5.0	0.99	5.18	0.11	0.12	0.12	0.07	0.10

1. Inductance shown for each winding, measured at 100 kHz, 0.1 Vrms, 0 Adc on an Agilent/HP 4284A LCR meter or equivalent. When leads are connected in parallel, inductance is the same value. When leads are connected in series, inductance is four times the value
2. DCR is for each winding. When leads are connected in parallel, DCR is half the value. When leads are connected in series, DCR is twice the value
3. SRF measured using an Agilent/HP 4191A or equivalent. When leads are connected in parallel, SRF is the same value
4. Leakage inductance is for L1 and is measured with L2 shorted
5. DC current at 25 °C that causes the specified inductance drop from its value without current. It is the sum of the current flowing in both windings
6. Equal current when applied to each winding simultaneously that causes a 40 °C temperature rise from 25 °C ambient. This information is for reference only and does not represent absolute maximum ratings
7. Maximum current when applied to one winding that causes a 40 °C temperature rise from 25 °C ambient. This information is for reference only and does not represent absolute maximum ratings
8. Electrical specifications at 25 °C
9. Ambient temperature -40 °C to +85 °C with (40 °C rise) I rms current
10. Maximum part temperature +125 °C (ambient + temp rise)
11. Storage temperature Component: -40 °C to +125 °C
12. Tape and reel packaging: -40 °C to +80 °C
13. Winding to winding isolation 100 Vrms, one minute
14. Resistance to soldering heat Max three 40 second reflows at +260 °C , parts cooled to room temperature between cycles
15. Packaging 1000/7 " reel; 3500/13 " reel

# PHYSICAL CHARACTERISTICS & WINDING:

Dimensions are in mm

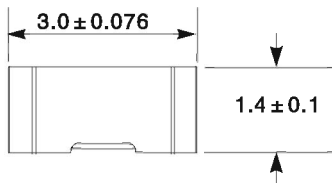
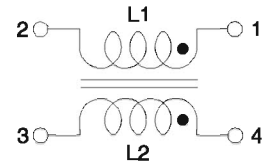
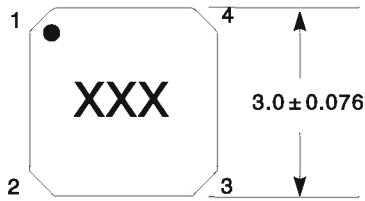

Recommended Land Pattern

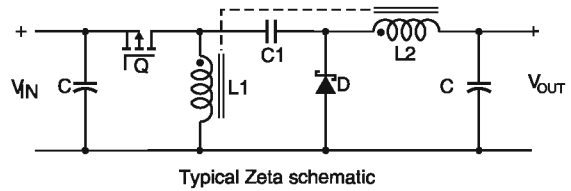
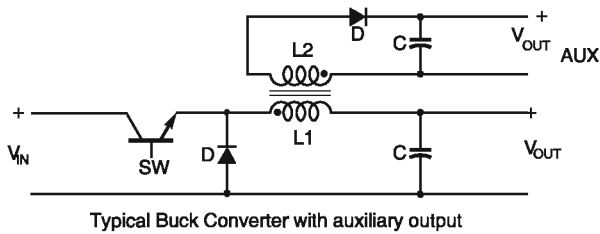
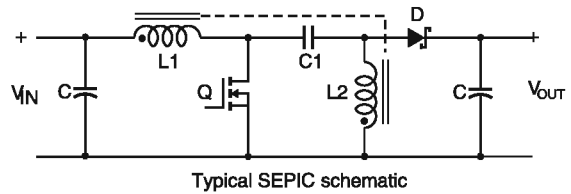
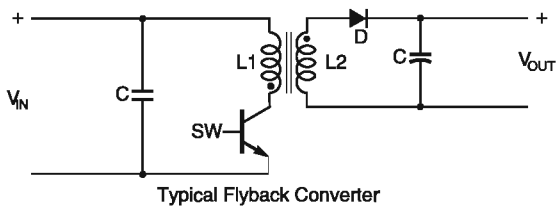
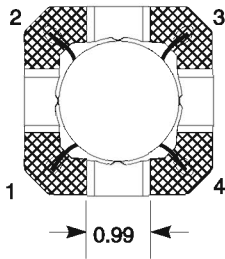
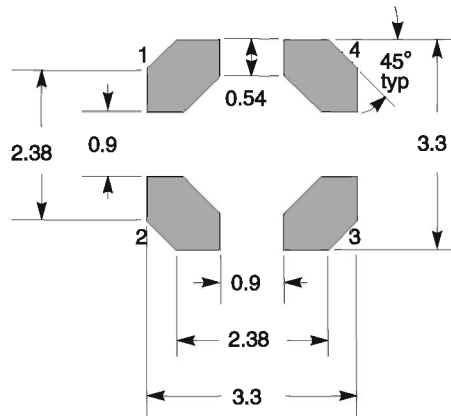

# PERFORMANCE CURVE:

TYPICAL L VS CURRENT

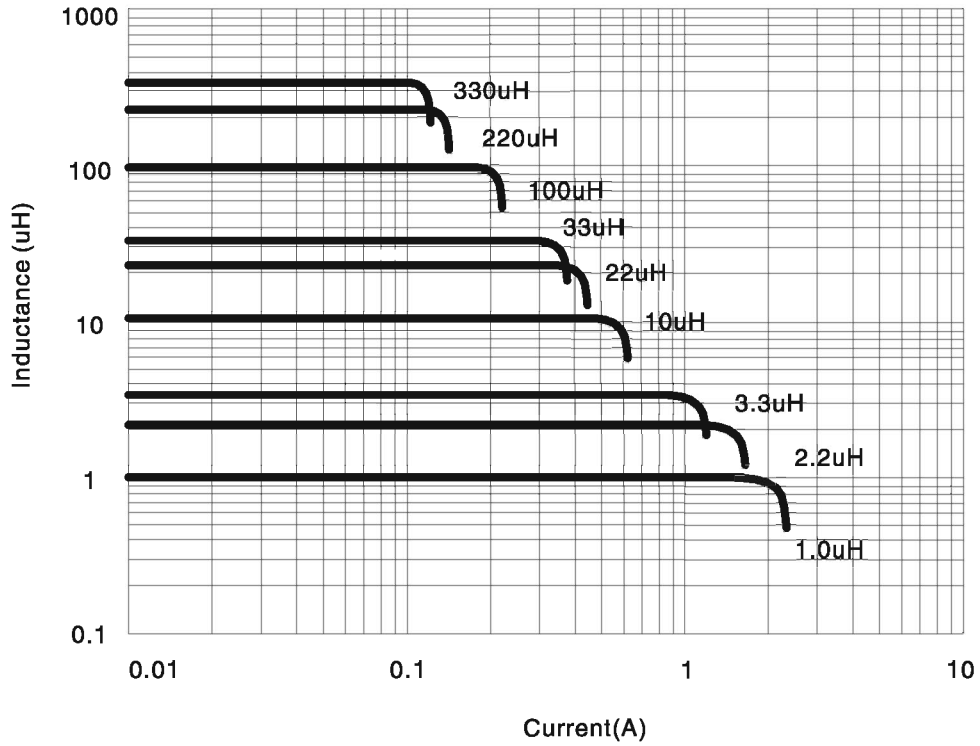

TYPICAL L VS FREQUENCY

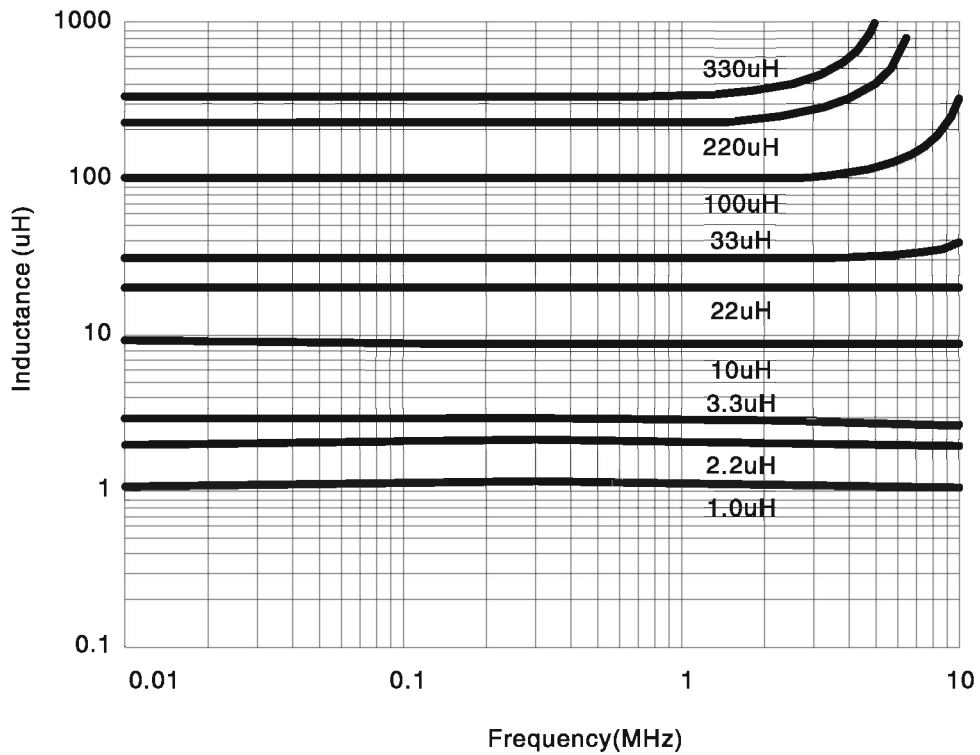

# COUPLED INDUCTORS, COMMON MODE CHOKES

## SDRH4012D SERIES

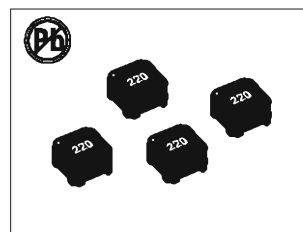

### FEATURES:

- Only 1.1 mm high and 4 mm square
- Ideal for use in flyback, multi-output buck, SEPIC and Zeta applications
- High inductance, high efficiency and excellent current handling
- Can also be used as two single inductors connected in series or parallel or as a common mode choke
- AEC-Q200 Grade 1 (40°C to +125°C)

### ELECTRICAL CHARACTERISTICS:

Part number SDRH4012D-	Inductance (uH)	DCR max (Ohms)	SRF typ (Mhz)	Coupling coefficient typ	Leakage L typ (uH)	Isat (A)			Irms (A)	
						10% drop	20% drop	30% drop	both windings	one windings
R33N	0.33 +30%	0.042	255	0.94	0.06	5.2	5.4	5.6	1.87	2.65
R56N	0.56 +30%	0.087	185	0.95	0.08	3.7	3.8	3.9	1.30	1.84
R82N	0.82 +30%	0.100	130	0.97	0.09	3.2	3.3	3.4	1.21	1.72
1R5N	1.5 +30%	0.185	86	0.97	0.11	2.50	2.81	2.91	1.15	1.62
2R2N	2.2 +30%	0.235	70	0.98	0.14	2.30	2.40	2.50	0.95	1.35
3R3N	3.3 +30%	0.320	48	0.98	0.16	1.80	1.90	2.00	0.75	1.06
4R7M	4.7 +20%	0.500	39	0.98	0.18	1.70	1.80	1.90	0.65	0.92
5R6M	5.6 +20%	0.620	32	0.99	0.20	1.60	1.70	1.80	0.55	0.78
6R8M	6.8 +20%	0.530	31	0.99	0.22	1.20	1.52	1.63	0.60	0.86
8R2M	8.2 +20%	0.600	29	0.99	0.24	1.10	1.20	1.30	0.55	0.78
100M	10 +20%	0.750	25	0.99	0.26	0.98	1.00	1.10	0.50	0.71
150M	15 +20%	1.13	21	0.99	0.30	0.90	0.92	0.94	0.43	0.60
220M	22 +20%	1.63	15	0.99	0.34	0.70	0.82	0.84	0.34	0.48
330M	33 +20%	1.83	12	>0.99	0.41	0.37	0.57	0.58	0.31	0.44
470M	47 +20%	2.52	8.8	>0.99	0.51	0.33	0.39	0.40	0.28	0.39
680M	68 +20%	3.23	7.8	>0.99	0.66	0.27	0.36	0.37	0.25	0.36
820M	82 +20%	3.66	7.3	>0.99	0.75	0.27	0.27	0.29	0.23	0.31
101M	100 +20%	4.76	6.1	>0.99	0.86	0.22	0.28	0.29	0.20	0.27
121M	120 +20%	5.54	5.3	>0.99	0.98	0.21	0.26	0.27	0.19	0.27
151M	150 +20%	6.90	4.6	>0.99	1.19	0.18	0.26	0.27	0.17	0.23
181M	180 +20%	8.75	4.1	>0.99	1.40	0.16	0.21	0.23	0.14	0.18
221M	220 +20%	11.24	3.3	>0.99	1.66	0.15	0.16	0.17	0.12	0.17
331M	330 +20%	17.00	2.8	>0.99	2.45	0.13	0.16	0.16	0.10	0.14

1. Inductance shown for each winding, measured at 100 kHz, 0.1 Vrms, 0 Adc on an Agilent/HP 4284A LCR meter or equivalent. When leads are connected in parallel, inductance is the same value. When leads are connected in series, inductance is four times the value
2. DCR is for each winding. When leads are connected in parallel, DCR is half the value. When leads are connected in series, DCR is twice the value
3. SRF measured using an Agilent/HP 4191A or equivalent. When leads are connected in parallel, SRF is the same value
4. Leakage Inductance is for L1 and is measured with L2 shorted
5. DC current at 25 °C that causes the specified inductance drop from its value without current. It is the sum of the current flowing in both windings
6. Equal current when applied to each winding simultaneously that causes a 40 °C temperature rise from 25 °C ambient. This information is for reference only and does not represent absolute maximum ratings
7. Maximum current when applied to one winding that causes a 40 °C temperature rise from 25 °C ambient. This information is for reference only and does not represent absolute maximum ratings
8. Electrical specifications at 25 °C
9. Ambient temperature -40 °C to +125 °C with (40 °C rise) Irms current
10. Maximum part temperature +165 °C (ambient + temp rise)
11. Storage temperature Component: -40 °C to +165 °C
12. Tape and reel packaging: -40 °C to +80 °C
13. Winding to winding Isolation 100 Vrms, one minute
14. Resistance to soldering heat Max three 40 second reflows at +260 °C , parts cooled to room temperature between cycles
15. Packaging 1000/7 " reel; 3500/13 " reel

# PHYSICAL CHARACTERISTICS & WINDING:

Dimensions are in mm

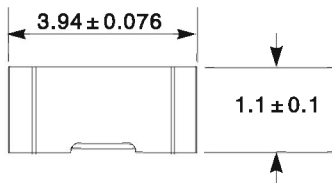
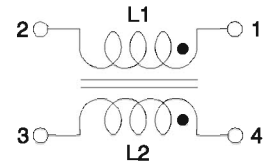
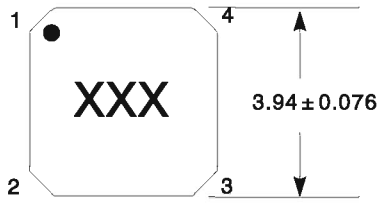

Recommended Land Pattern

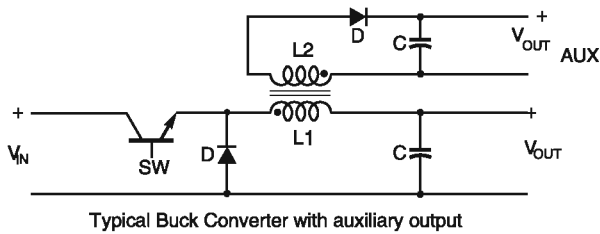
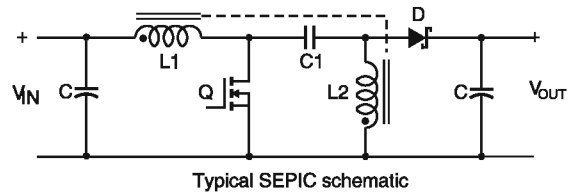
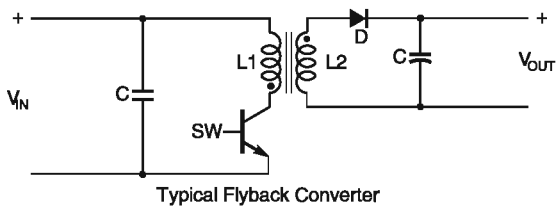
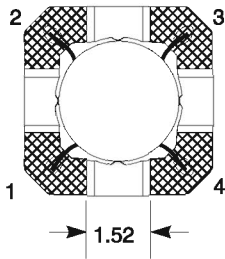
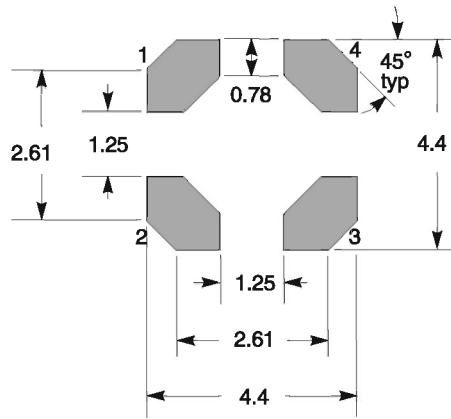

# PERFORMANCE CURVE:

TYPICAL L VS CURRENT

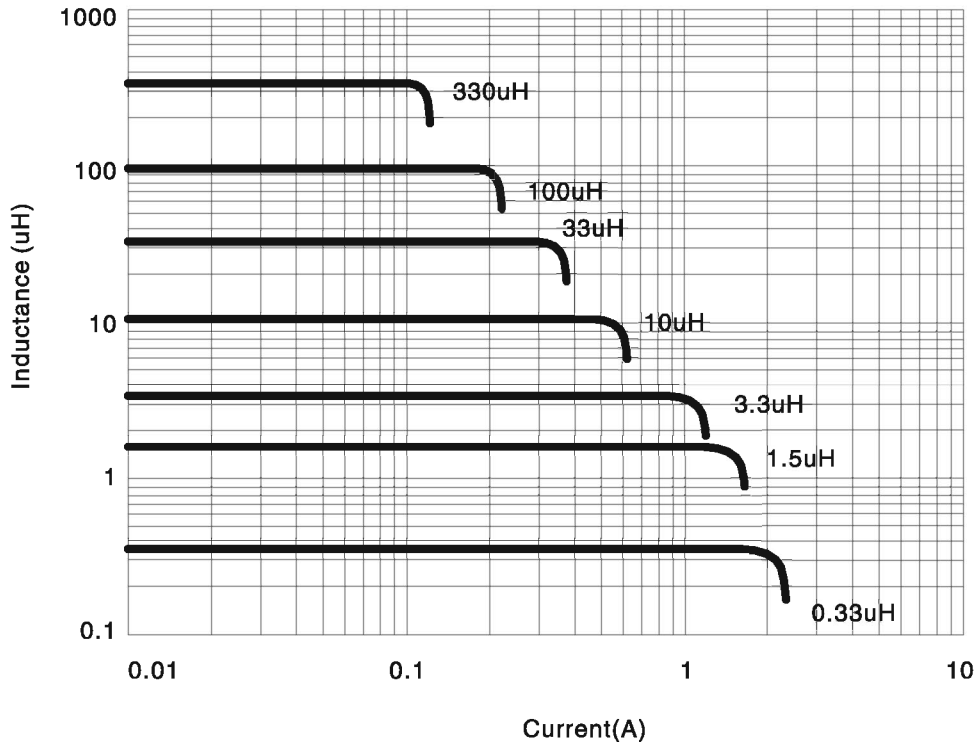

TYPICAL L VS FREQUENCY

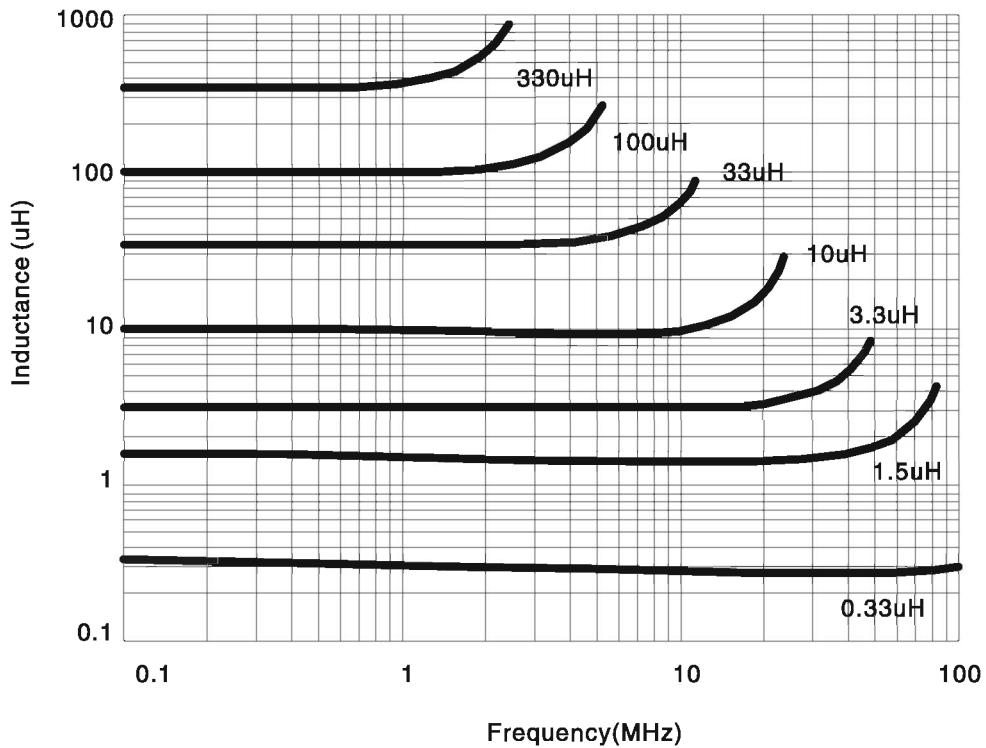

# COMMON MODE CHOKES SDRH4829D SERIES

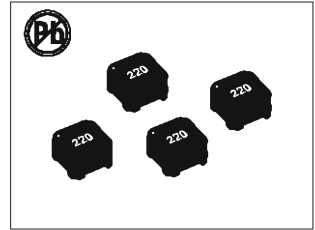

## FEATURES:

- Only 2.9 mm high and 4.8 mm square
- Ideal for use in both power line and signal line applications
- Common- and differential-mode filtering in a single device
- Winding to winding isolation (hipot) up to 2500 VDC
- 1500 Vdc (1000 Vrms), one minute isolation (hi-pot) between windings
- Can be used as coupled inductors for SEPIC applications
- UL Certified per File E219568

## ELECTRICAL CHARACTERISTICS:

Partnumber	Common mode impedance max (kΩ)	Cutoff frequency (MHZ)	Inductance (μH)		DCR max (Ohms)	Isolation (Vrms)	I <sub>rms</sub> (A)
			min	nom			
SDRH4829D-4R7Y	7.85 @ 66 MHz	410	3.76	4.7	0.322	1000	1.90
SDRH4829D-6R8Y	9.20 @ 56 MHz	470	5.44	6.8	0.395	1000	1.55
SDRH4829D-100Y	11.69 @ 40 MHz	340	8.00	10	0.490	1000	1.30
SDRH4829D-330Y	25.81 @ 19 MHz	240	26.4	33	0.895	1000	0.67
SDRH4829D-151Y	102.7 @ 9.6 MHz	130	120	150	3.82	1000	0.31
SDRH4829D-221Y	174.7 @ 7.5 MHz	83	176	220	5.25	1000	0.24

1. Frequency at which the differential mode attenuation equals -3dB
2. Inductance shown for each winding, measured at 100 kHz, 0.1 Vrms, 0 Adc on an Agilent/HP 4284A LCR meter or equivalent
3. DCR is for each winding.
4. 1000 Vrms, one minute isolation (hipot) between windings.
5. Current that causes a 40 °C temperature rise from 25 °C ambient. This information is for reference only and does not represent absolute maximum ratings
6. Electrical specifications at 25 °C
7. Ambient temperature -40 °C to +85 °C with (40 °C rise) I<sub>rms</sub> current. Maximum part temperature +125 °C (ambient + temp rise).
8. Storage temperature Component: -40 °C to +125 °C .
9. Tape and reel packaging: -40 °C to +80 °C

## PHYSICAL CHARACTERISTICS & WINDING:

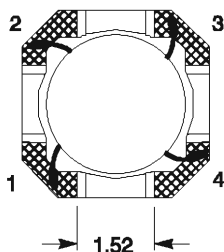
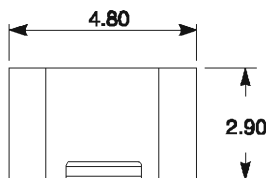
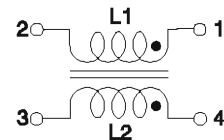
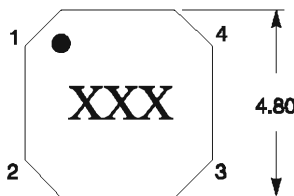

### Recommended Land Pattern

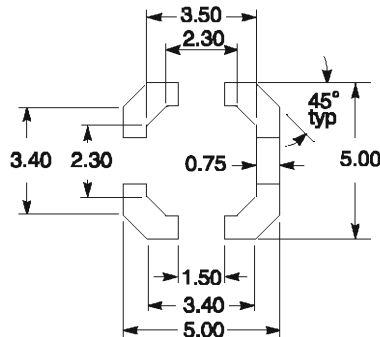

Dimensions are in mm

**PERFORMANCE CURVE:**

Typical Attenuation (Ref: 50 Ohms)

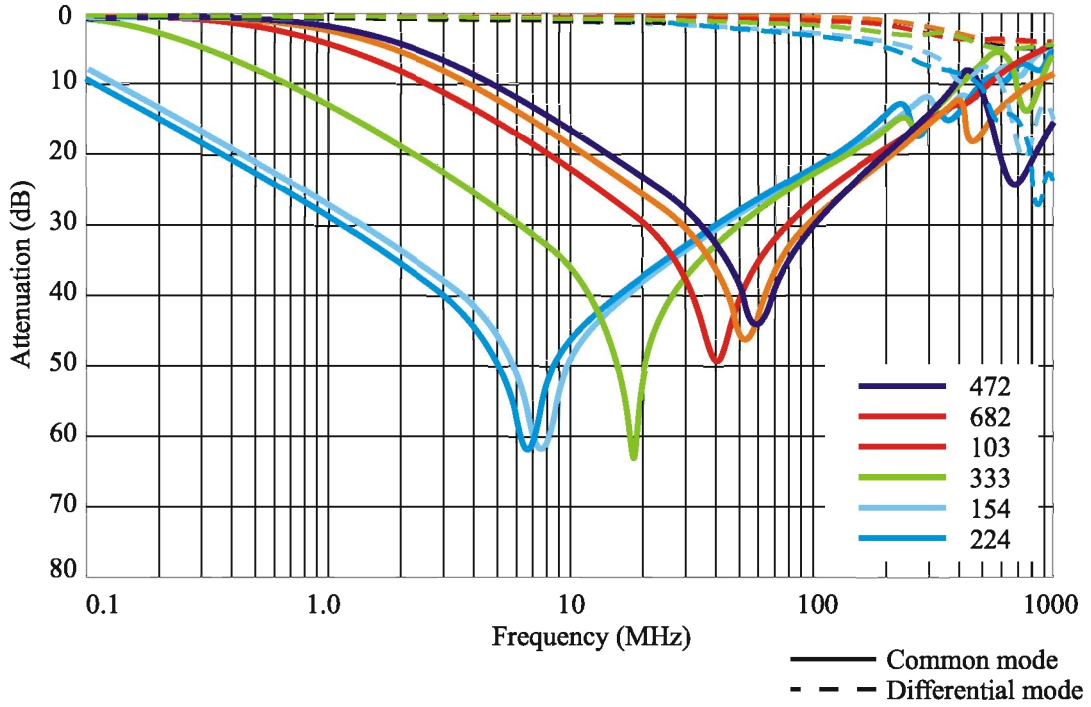

Typical Impedance vs Frequency

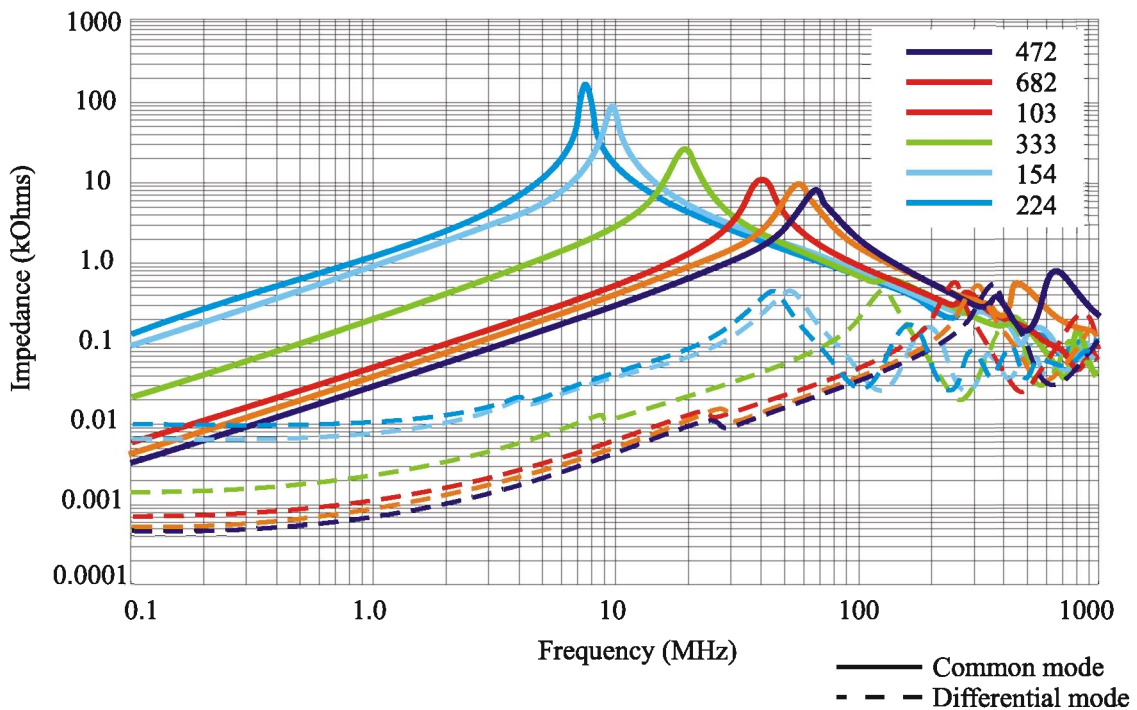

# COUPLED INDUCTORS, COMMON MODE CHOKES SDRH5010D SERIES

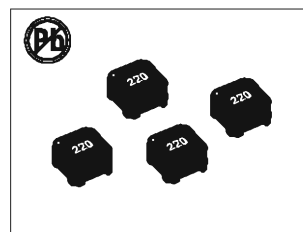

## FEATURES:

- Only 1.0 mm high and 5 mm square
- Ideal for use in flyback, multi-output buck, SEPIC and Zeta applications
- High inductance, high efficiency and excellent current handling
- Can also be used as two single inductors connected in series or parallel or as a common mode choke
- UL Certified per File E219588

## ELECTRICAL CHARACTERISTICS:

Part number SDRH5010D-	Inductance (uH) ±20%	DCR max (Ohms)	SRF typ (Mhz)	Coupling coefficient typ	Leakage L typ (uH)	Isat (A)			Irms (A)	
						10% drop	20% drop	30% drop	both windings	one windings
R68N	0.68 ±30%	0.07	191	0.95	0.07	2.6	2.7	2.8	1.95	2.76
1R0M	1.0	0.10	150	0.95	0.09	2.1	2.1	2.2	1.50	2.12
1R5M	1.5	0.15	134	0.97	0.09	1.7	1.8	1.8	1.20	1.70
2R2M	2.2	0.20	108	0.97	0.11	1.5	1.6	1.6	1.10	1.56
3R3M	3.3	0.27	83	0.98	0.13	1.2	1.3	1.3	0.95	1.34
4R7M	4.7	0.40	68	0.98	0.15	0.98	1.0	1.1	0.75	1.06
5R6M	5.6	0.45	60	0.99	0.16	0.90	0.93	0.94	0.70	0.99
6R8M	6.8	0.53	55	0.99	0.19	0.83	0.86	0.87	0.60	0.85
8R2M	8.2	0.70	50	0.99	0.22	0.74	0.77	0.78	0.50	0.71
100M	10	0.78	46	0.99	0.27	0.67	0.69	0.70	0.50	0.71
150M	15	1.19	33	0.99	0.34	0.53	0.55	0.56	0.42	0.59
220M	22	1.58	26	0.99	0.40	0.45	0.47	0.48	0.35	0.49
330M	33	2.50	23	0.99	0.48	0.37	0.38	0.39	0.30	0.42
470M	47	3.48	17.0	0.99	0.63	0.31	0.32	0.33	0.25	0.35
680M	68	5.10	14.9	0.99	0.90	0.25	0.26	0.27	0.19	0.26
101M	100	8.0	11.2	0.99	1.39	0.21	0.22	0.22	0.15	0.21
151M	150	11.7	9.90	0.99	2.10	0.17	0.17	0.18	0.12	0.16
221M	220	15.2	8.05	0.99	3.02	0.14	0.15	0.15	0.11	0.15

1. Inductance shown for each winding, measured at 100 kHz, 0.1 Vrms, 0 A dc on an Agilent/HP 4284A LCR meter or equivalent. When leads are connected in parallel, inductance is the same value. When leads are connected in series, inductance is four times the value
2. DCR is for each winding. When leads are connected in parallel, DCR is half the value. When leads are connected in series, DCR is twice the value
3. SRF measured using an Agilent/HP 4191A or equivalent. When leads are connected in parallel, SRF is the same value
4. Leakage Inductance is for L1 and is measured with L2 shorted
5. DC current at 25 °C that causes the specified inductance drop from its value without current. It is the sum of the current flowing in both windings
6. Equal current when applied to each winding simultaneously that causes a 40 °C temperature rise from 25 °C ambient. This information is for reference only and does not represent absolute maximum ratings
7. Maximum current when applied to one winding that causes a 40 °C temperature rise from 25 °C ambient. This information is for reference only and does not represent absolute maximum ratings
8. Electrical specifications at 25 °C
9. Ambient temperature -40 °C to +85 °C with (40 °C rise) I rms current
10. Maximum part temperature +125 °C (ambient + temp rise)
11. Storage temperature Component: -40 °C to +125 °C
12. Tape and reel packaging: -40 °C to +80 °C
13. Winding to winding isolation 100 Vrms, one minute
14. Resistance to soldering heat Max three 40 second reflows at +260 °C , parts cooled to room temperature between cycles
15. Packaging 1000/7 " reel; 3500/13 " reel

# PHYSICAL CHARACTERISTICS & WINDING:

Dimensions are in mm

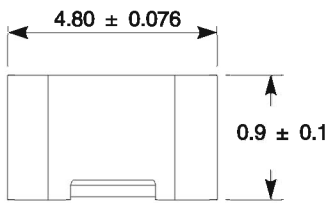
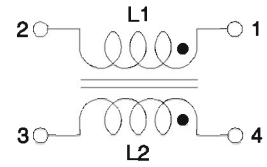
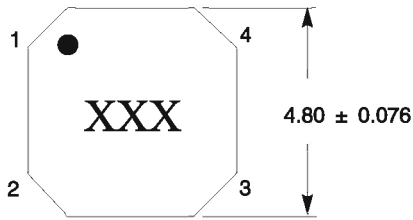

Recommended Land Pattern

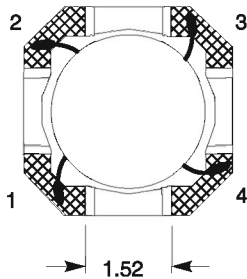
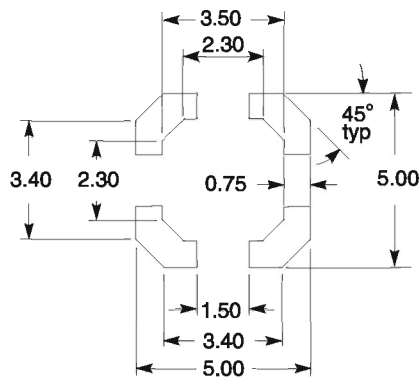

Dimensions are in mm

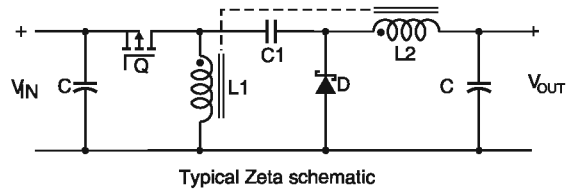
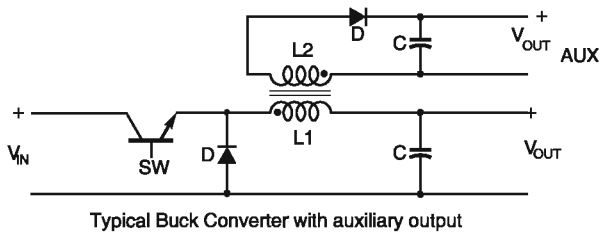
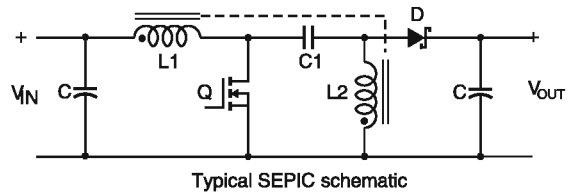
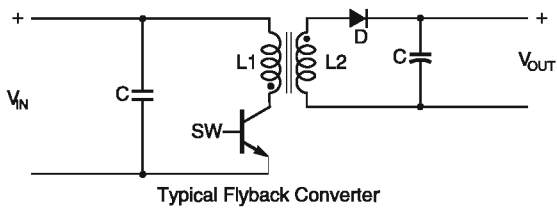

# PERFORMANCE CURVE:

### TYPICAL L VS CURRENT

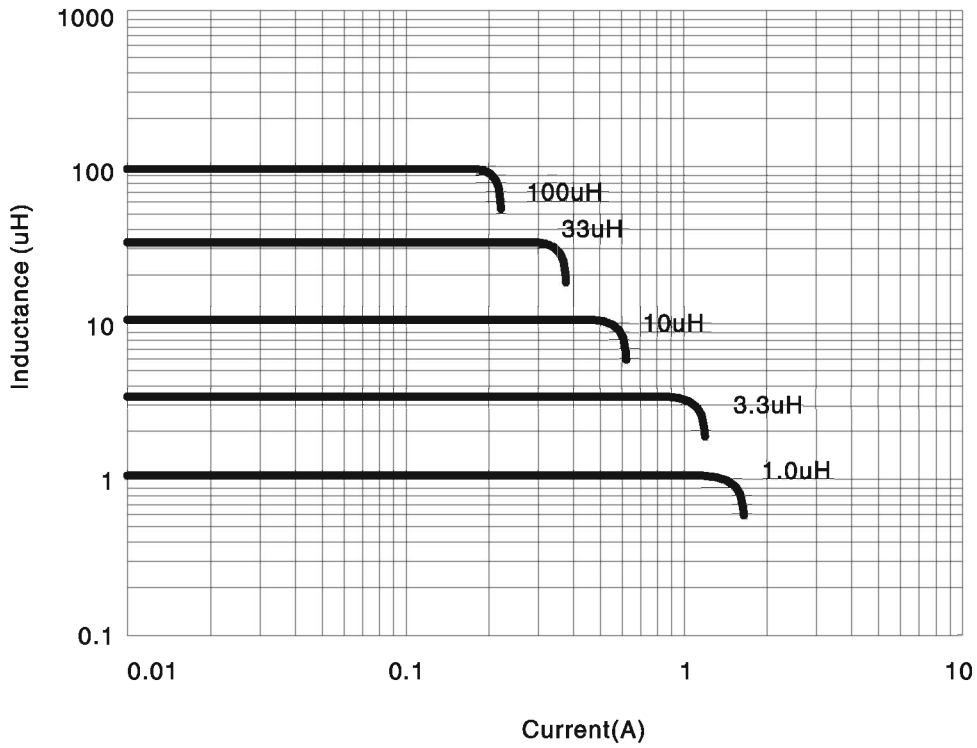

### TYPICAL L VS FREQUENCY

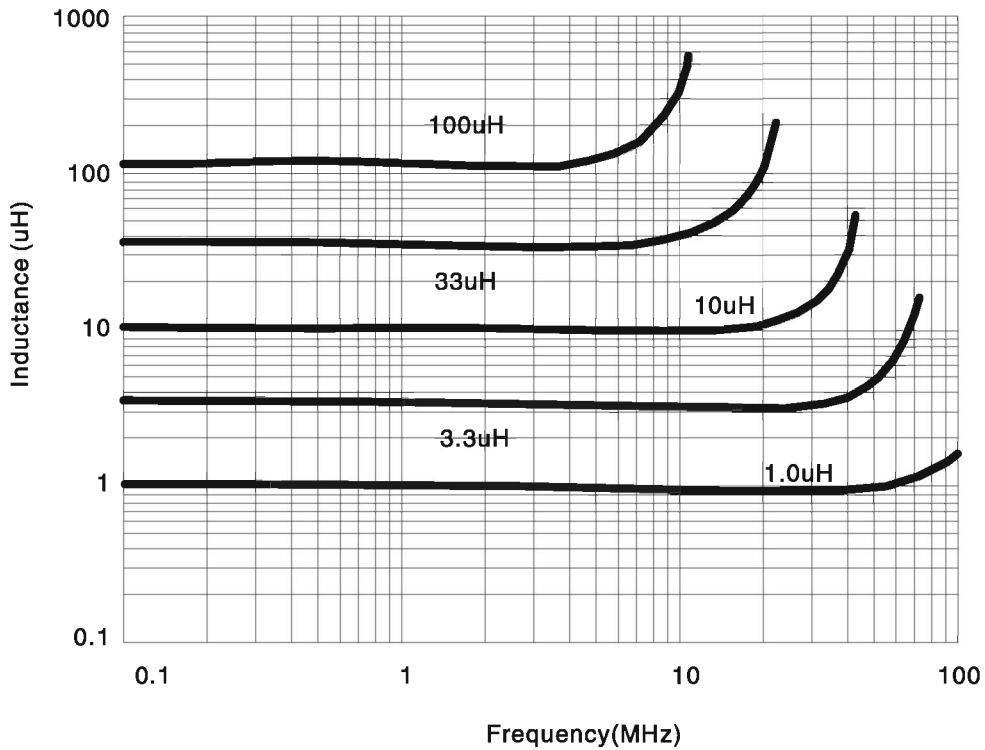

# COUPLED INDUCTORS, COMMON MODE CHOKES

## SDRH5030D SERIES

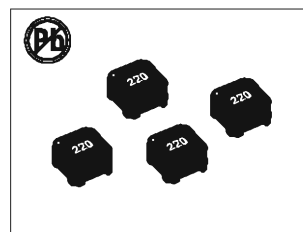

### FEATURES:

- Only 3.0 mm high and 5 mm square
- Ideal for use in flyback, multi-output buck, SEPIC and Zeta applications
- High inductance, high efficiency and excellent current handling
- Can also be used as two single inductors connected in series or parallel or as a common mode choke
- UL Certified per File E219588

### ELECTRICAL CHARACTERISTICS:

Part number SDRH5030D-	Inductance (uH)	DCR max (Ohms)	SRF typ (Mhz)	Coupling coefficient typ	Leakage L typ (uH)	Isat (A)			Irms (A)	
						10% drop	20% drop	30% drop	both windings	one windings
R57N	0.57 +30%	0.031	233	0.93	0.07	5.60	5.80	6.03	2.30	3.25
R78N	0.78 +30%	0.038	172	0.94	0.08	4.60	4.80	5.00	2.25	3.18
1R0N	1.0 +30%	0.042	153	0.95	0.09	4.30	4.49	4.67	2.20	3.11
1R5M	1.5 +20%	0.048	118	0.97	0.09	3.90	4.20	4.30	2.05	2.90
2R2M	2.2 +20%	0.067	87.0	0.98	0.10	2.80	2.98	3.07	1.95	2.76
3R3M	3.3 +20%	0.077	61.0	0.98	0.10	2.50	2.70	2.80	1.70	2.40
4R7M	4.7 +20%	0.111	49.0	0.99	0.11	2.10	2.20	2.20	1.40	1.98
5R6M	5.6 +20%	0.125	44.0	0.99	0.11	1.80	1.80	1.89	1.35	1.91
6R8M	6.8 +20%	0.159	40.0	0.99	0.12	1.40	1.48	1.48	1.20	1.70
100M	10 +20%	0.210	28.0	0.99	0.13	1.20	1.20	1.20	1.05	1.48
150M	15 +20%	0.298	23.0	0.99	0.15	1.00	1.17	1.17	0.85	1.20
220M	22 +20%	0.452	17.0	>0.99	0.17	0.88	0.98	0.98	0.70	0.99
330M	33 +20%	0.565	16.0	>0.99	0.20	0.73	0.77	0.78	0.60	0.85
470M	47 +20%	0.806	12.0	>0.99	0.24	0.59	0.63	0.65	0.50	0.71
680M	68 +20%	1.13	9.00	>0.99	0.29	0.50	0.54	0.55	0.43	0.61
101M	100 +20%	1.79	8.44	>0.99	0.37	0.47	0.54	0.56	0.33	0.47
151M	150 +20%	2.43	6.72	>0.99	0.46	0.38	0.43	0.45	0.28	0.40
221M	220 +20%	3.30	5.53	>0.99	0.54	0.31	0.35	0.36	0.24	0.34
331M	330 +20%	5.36	4.17	>0.99	0.65	0.25	0.25	0.32	0.18	0.25
471M	470 +20%	7.51	3.52	>0.99	0.76	0.21	0.24	0.26	0.15	0.21
681M	680 +20%	10.8	2.93	>0.99	0.89	0.17	0.20	0.21	0.13	0.18
102M	1000 +20%	16.5	2.33	>0.99	1.20	0.15	0.17	0.17	0.10	0.14

1. Inductance shown for each winding, measured at 100 kHz, 0.1 Vrms, 0 Adc on an Agilent/HP 4284A LCR meter or equivalent. When leads are connected in parallel, inductance is the same value. When leads are connected in series, inductance is four times the value
2. DCR is for each winding. When leads are connected in parallel, DCR is half the value. When leads are connected in series, DCR is twice the value
3. SRF measured using an Agilent/HP 4191A or equivalent. When leads are connected in parallel, SRF is the same value
4. Leakage Inductance is for L1 and is measured with L2 shorted
5. DC current at 25 °C that causes the specified inductance drop from its value without current. It is the sum of the current flowing in both windings
6. Equal current when applied to each winding simultaneously that causes a 40 °C temperature rise from 25 °C ambient. This information is for reference only and does not represent absolute maximum ratings
7. Maximum current when applied to one winding that causes a 40 °C temperature rise from 25 °C ambient. This information is for reference only and does not represent absolute maximum ratings
8. Electrical specifications at 25 °C
9. Ambient temperature -40 °C to +85 °C with (40 °C rise) I rms current
10. Maximum part temperature +125 °C (ambient + temp rise)
11. Storage temperature Component: -40 °C to +125 °C
12. Tape and reel packaging: -40 °C to +80 °C
13. Winding to winding isolation 100 Vrms, one minute
14. Resistance to soldering heat Max three 40 second reflows at +260 °C , parts cooled to room temperature between cycles
15. Packaging 1000/7 " reel; 3500/13 " reel

# PHYSICAL CHARACTERISTICS & WINDING:

Dimensions are in mm

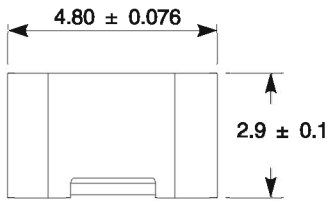
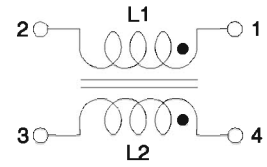
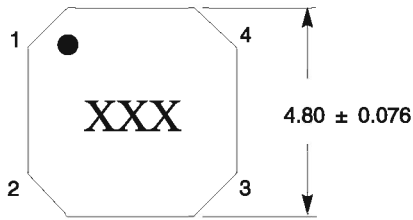

Recommended Land Pattern

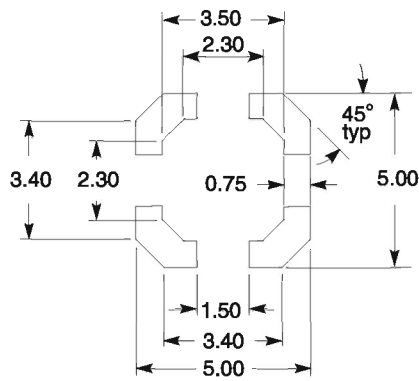

Dimensions are in mm

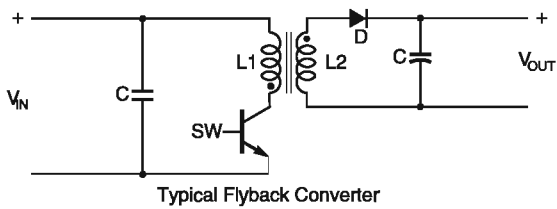
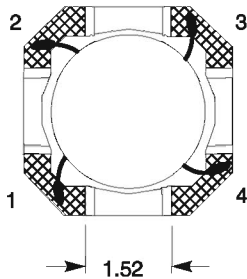

Typical Flyback Converter

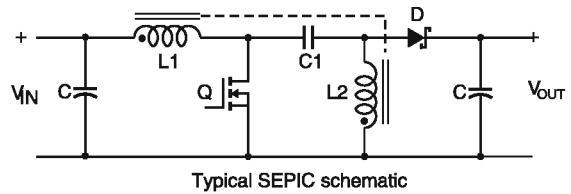

Typical SEPIC schematic

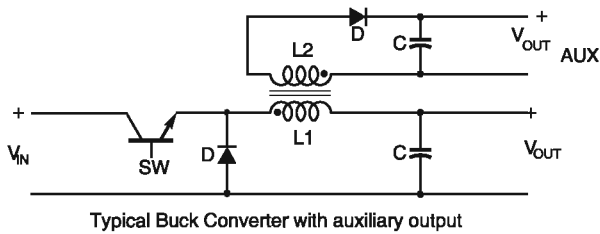

Typical Buck Converter with auxiliary output

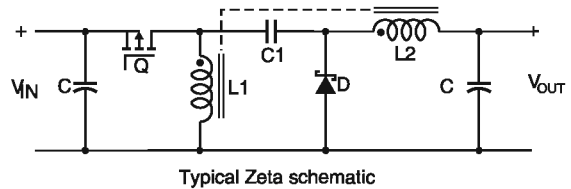

Typical Zeta schematic

# PERFORMANCE CURVE:

TYPICAL L VS CURRENT

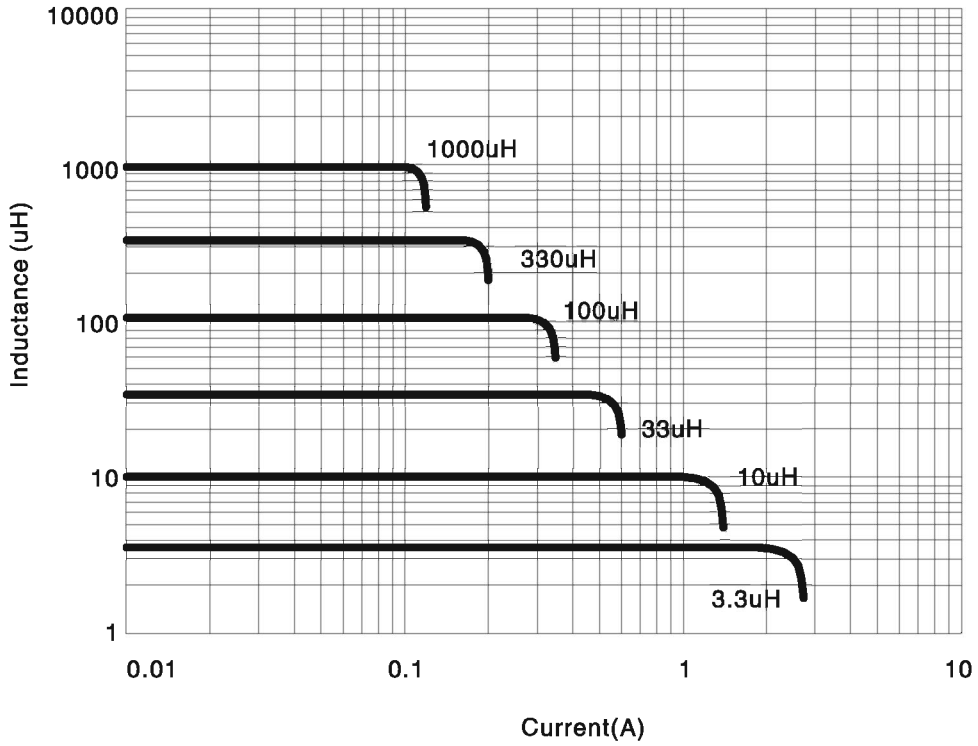

TYPICAL L VS FREQUENCY

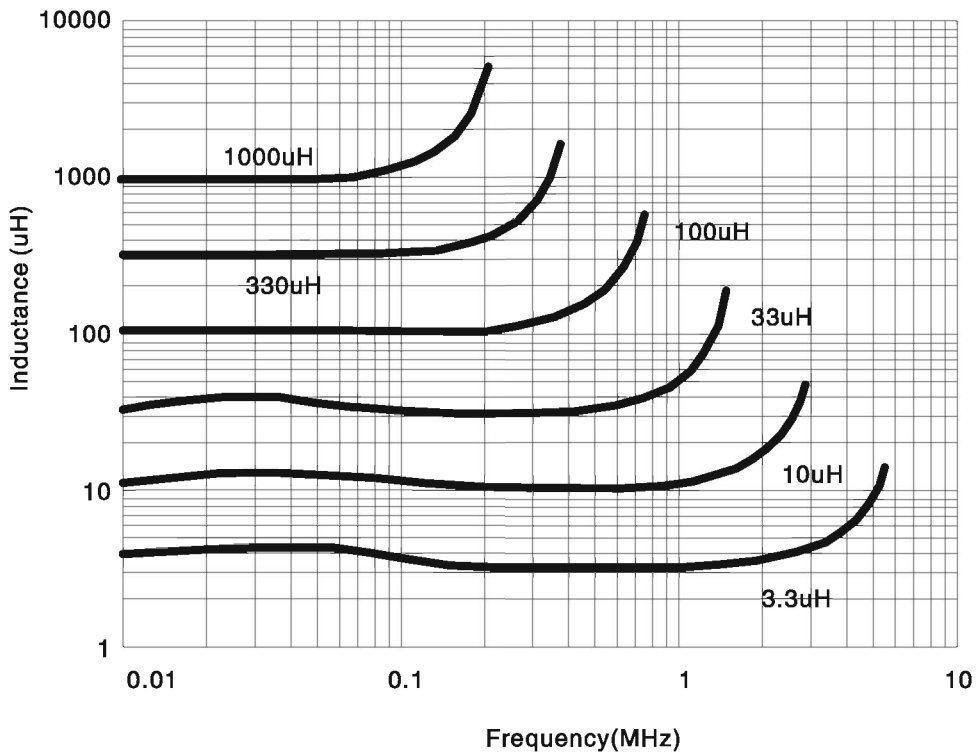

# SMD COUPLED INDUCTORS SDRH5228D SERIES



## FEATURES:

- 5.2X5.2 mm footprint, 2.85mm high coupled inductors.
- Low DCR and excellent current handling.
- They can be used as two single inductors connected in parallel, as a 1 : 1 transformer or as an autotransformer when connected in series.
- Winding to winding isolation (hipot) up to 2500 VDC.

## ELECTRICAL CHARACTERISTICS:

Part Number	L (uH) ± 20%	DCR (Ω) Max	SRF (MHz) Typ	Coupling Coefficient Typ	Isat(A) Typ			Irms(A) Typ	
					10% Drop	20% Drop	30% Drop	Both winding	One winding
SDRH5228D-100M	10	0.3	28.0	0.99	1.2	1.3	1.4	0.682	0.964
SDRH5228D-220M	22	0.65	18.0	0.99	0.78	0.87	0.95	0.438	0.619
SDRH5228D-330M	33	0.95	15.0	0.99	0.64	0.71	0.78	0.341	0.482
SDRH5228D-680M	68	1.8	11.0	0.99	0.45	0.5	0.54	0.255	0.361
SDRH5228D-101M	100	2.65	10.0	0.99	0.37	0.41	0.45	0.205	0.29
SDRH5228D-151M	150	4.3	6.7	1.00	0.3	0.33	0.36	0.155	0.219
SDRH5228D-221M	220	6.1	5.8	1.00	0.25	0.28	0.3	0.14	0.198

1. Inductance shown for each winding, measured at 100 kHz, 0.1 Vrms, 0 Adc on an Agilent/HP 4284A LCR meter or equivalent. When leads are connected in parallel, inductance is the same value. When leads are connected in series, inductance is four times the value.
2. DCR is for each winding. When leads are connected in parallel, DCR is half the value. When leads are connected in series, DCR is twice the value.
3. SRF measured using an Agilent/HP4294A network analyzer or equivalent. When leads are connected in parallel, SRF is the same value.
4. Isat: DC current, at which the inductance drops the specified amount from its value without current. It is the sum of the current flowing in both windings.
5. Irms, both windings: Equal current when applied to each winding simultaneously that causes a 40 °C temperature rise from 25 °C ambient.
6. Irms, one winding: Maximum current when applied to one winding that causes a 40 °C temperature rise from 25 °C ambient.
7. Ambient temperature -40 °C to +85 °C with (40 °C rise) Irms current. Maximum part temperature +125 °C (ambient + temp rise).
8. Storage temperature Component: -40 °C to +125 °C .
9. Tape and reel packaging: -40 °C to +80 °C
10. Winding to winding isolation (hipot) 2500 VDC
11. Resistance to soldering heat Three reflows at >217 °C for 90 seconds (+280 °C ± 5 °C for 20-40 seconds)

## PHYSICAL CHARACTERISTICS & WINDING:

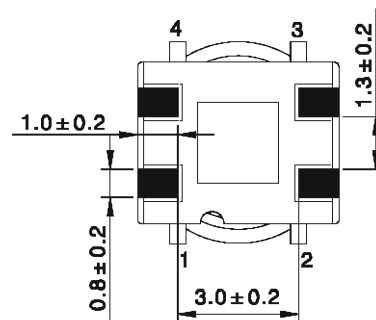
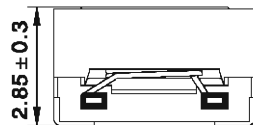
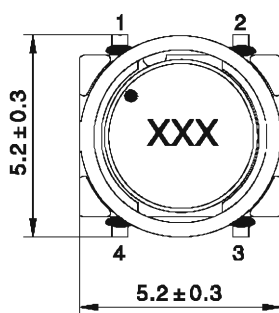

### WINDING

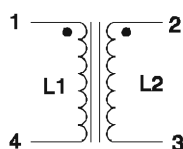

### LAND PATTERN

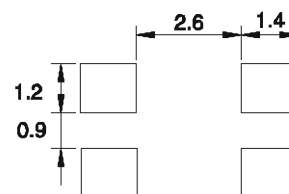

**PERFORMANCE CURVE:**

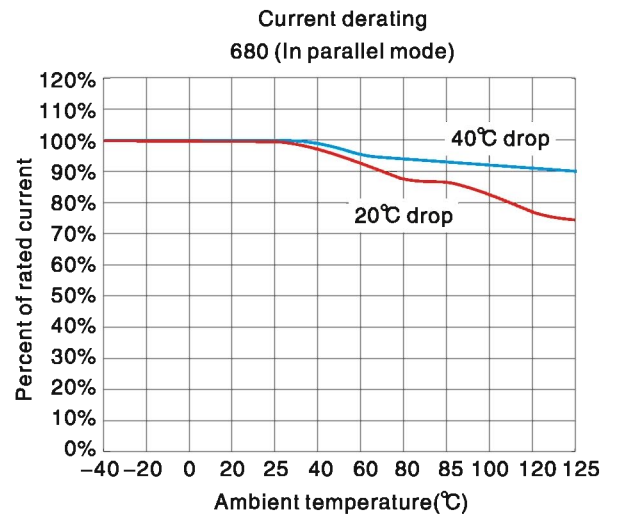
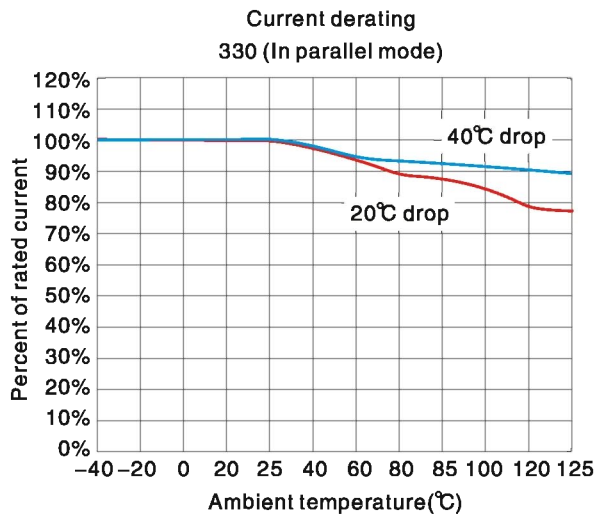
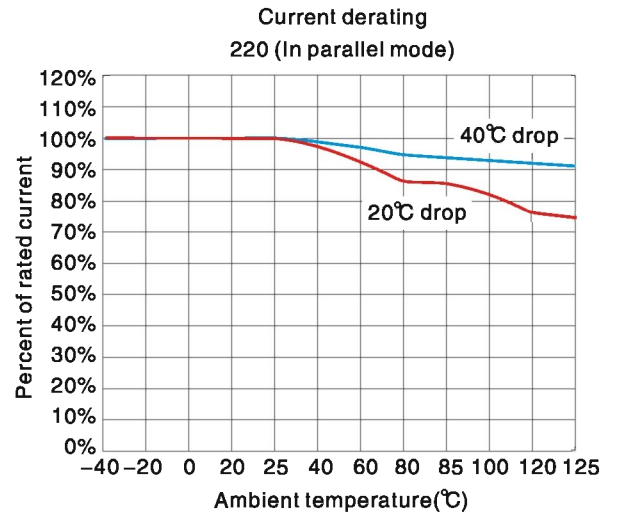
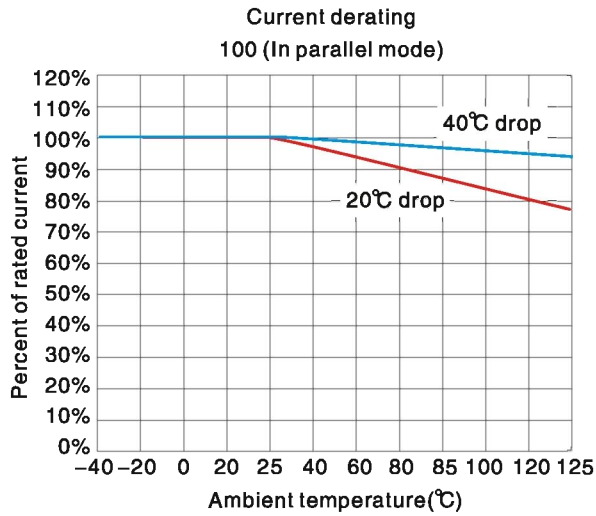
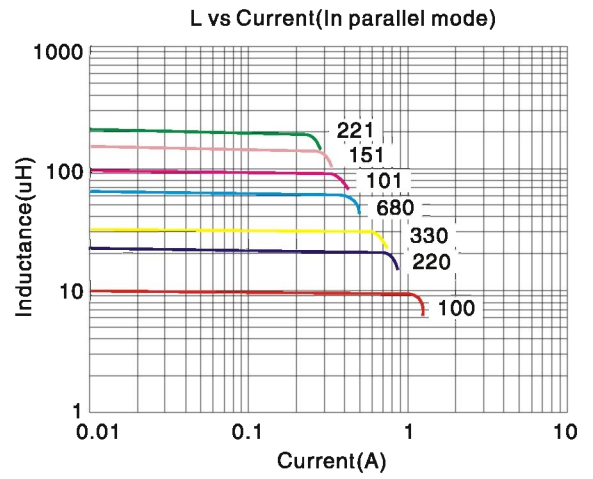
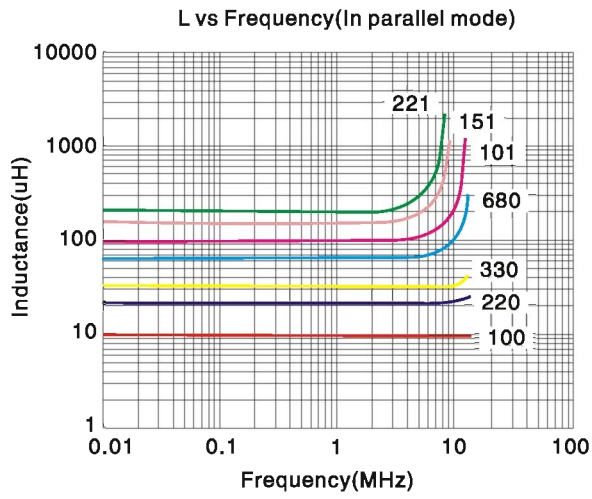

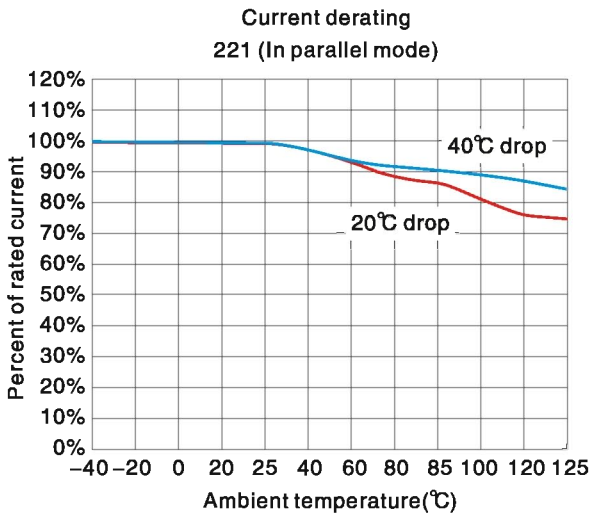
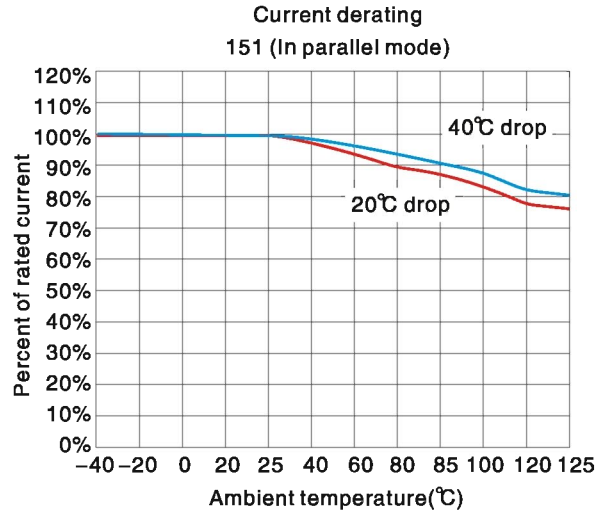
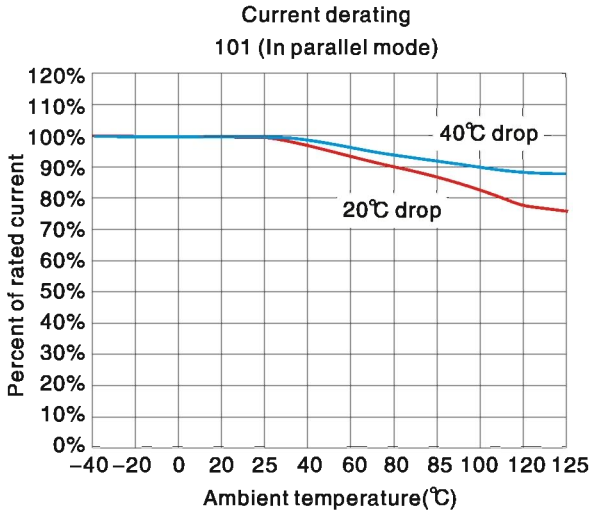

**TYPICAL APPLY:**

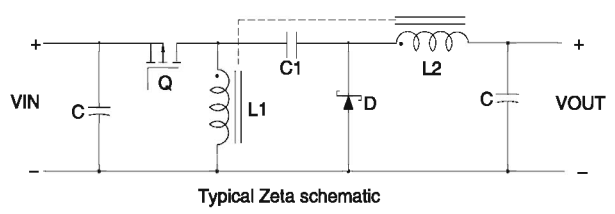
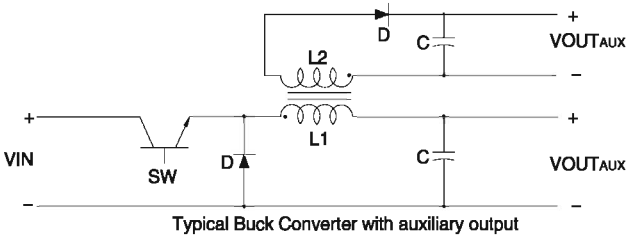
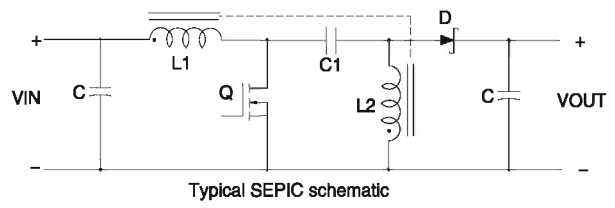
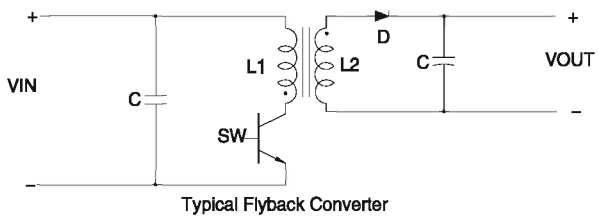

# COUPLED INDUCTORS, COMMON MODE CHOKES SDRH6235D SERIES

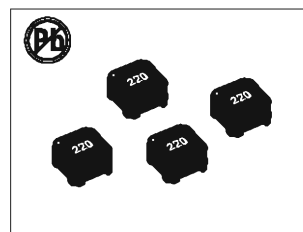

## FEATURES:

- Only 3.5 mm high and 6.0 mm square
- Ideal for use in flyback, multi-output buck, SEPIC and Zeta applications
- High inductance, high efficiency and excellent current handling
- Can also be used as two single inductors connected in series or parallel or as a common mode choke
- AEC-Q200 Grade 1 (40°C to +125°C)

## ELECTRICAL CHARACTERISTICS:

Part number SDRH6235D-	Inductance ± 20% (uH)	DCR max (Ohms)	SRF typ (Mhz)	Coupling coefficient typ	Leakage L typ (uH)	Isat (A)			Irms (A)	
						10% drop	20% drop	30% drop	both windings	one windings
6R8M	6.8	0.120	31	0.99	0.10	2.80	3.00	3.12	1.40	1.98
100M	10	0.157	26	0.99	0.12	2.50	2.70	2.80	1.30	1.83
220M	22	0.300	15	> 0.99	0.15	1.50	1.67	1.73	0.85	1.20
470M	47	0.620	9.7	> 0.99	0.21	0.90	0.98	0.99	0.60	0.85
101M	100	1.20	7.0	> 0.99	0.45	0.62	0.72	0.74	0.40	0.56
471M	470	3.50	3.0	> 0.99	0.61	0.18	0.22	0.23	0.25	0.35
102M	1000	7.00	1.9	> 0.99	1.05	0.12	0.14	0.15	0.15	0.21
152M	1500	10.8	1.5	> 0.99	1.70	0.12	0.12	0.13	0.14	0.20
202M	2000	16.0	1.3	> 0.99	2.10	0.08	0.11	0.12	0.11	0.16

1. Inductance shown for each winding, measured at 100 kHz, 0.1 Vrms, 0 Adc on an Agilent/HP 4284A LCR meter or equivalent. When leads are connected in parallel, inductance is the same value. When leads are connected in series, inductance is four times the value
2. DCR is for each winding. When leads are connected in parallel, DCR is half the value. When leads are connected in series, DCR is twice the value
3. SRF measured using an Agilent/HP 4191A or equivalent. When leads are connected in parallel, SRF is the same value
4. Leakage Inductance is for L1 and is measured with L2 shorted
5. DC current at 25 °C that causes the specified inductance drop from its value without current. It is the sum of the current flowing in both windings
6. Equal current when applied to each winding simultaneously that causes a 40 °C temperature rise from 25 °C ambient. This information is for reference only and does not represent absolute maximum ratings
7. Maximum current when applied to one winding that causes a 40 °C temperature rise from 25 °C ambient. This information is for reference only and does not represent absolute maximum ratings
8. Electrical specifications at 25 °C
9. Ambient temperature -40 °C to +125 °C with (40 °C rise) I rms current
10. Maximum part temperature +165 °C (ambient + temp rise)
11. Storage temperature Component: -40 °C to +165 °C
12. Tape and reel packaging: -40 °C to +80 °C
13. Winding to winding isolation 100 Vrms, one minute
14. Resistance to soldering heat Max three 40 second reflows at +260 °C , parts cooled to room temperature between cycles
15. Packaging 1000/7" reel; 3500/13" reel

# PHYSICAL CHARACTERISTICS & WINDING:

Dimensions are in mm

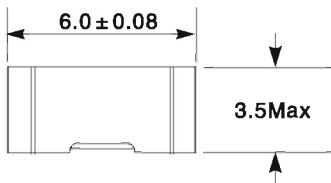
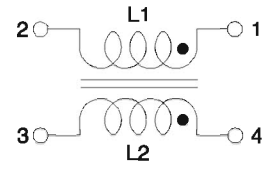
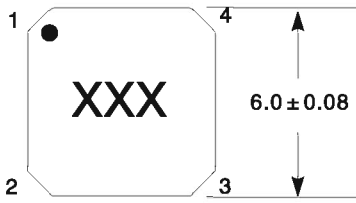

Recommended Land Pattern

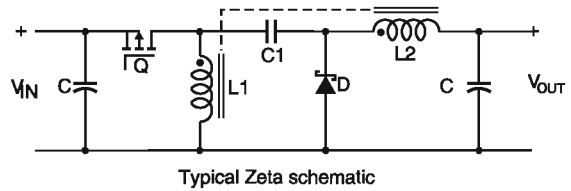
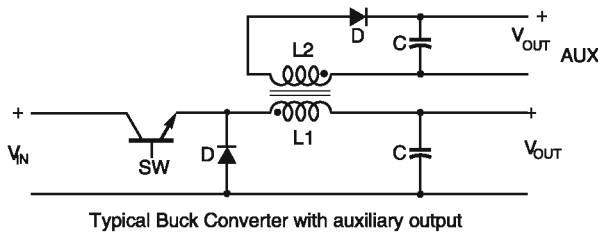
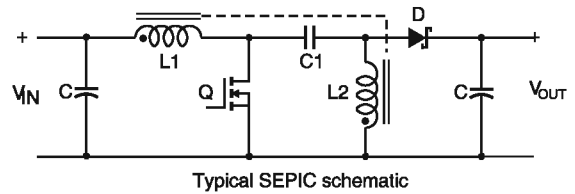
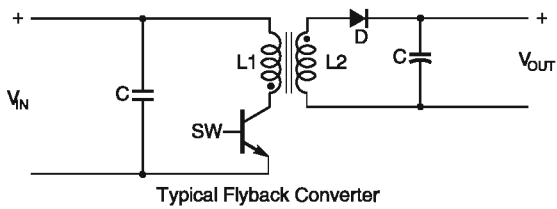
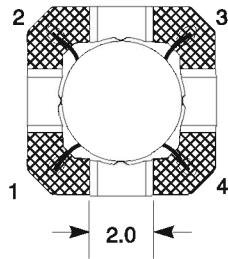
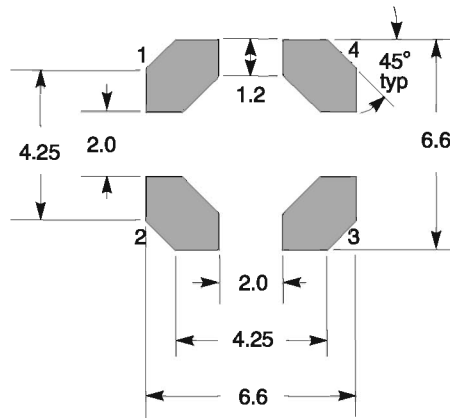

# PERFORMANCE CURVE:

TYPICAL L VS CURRENT

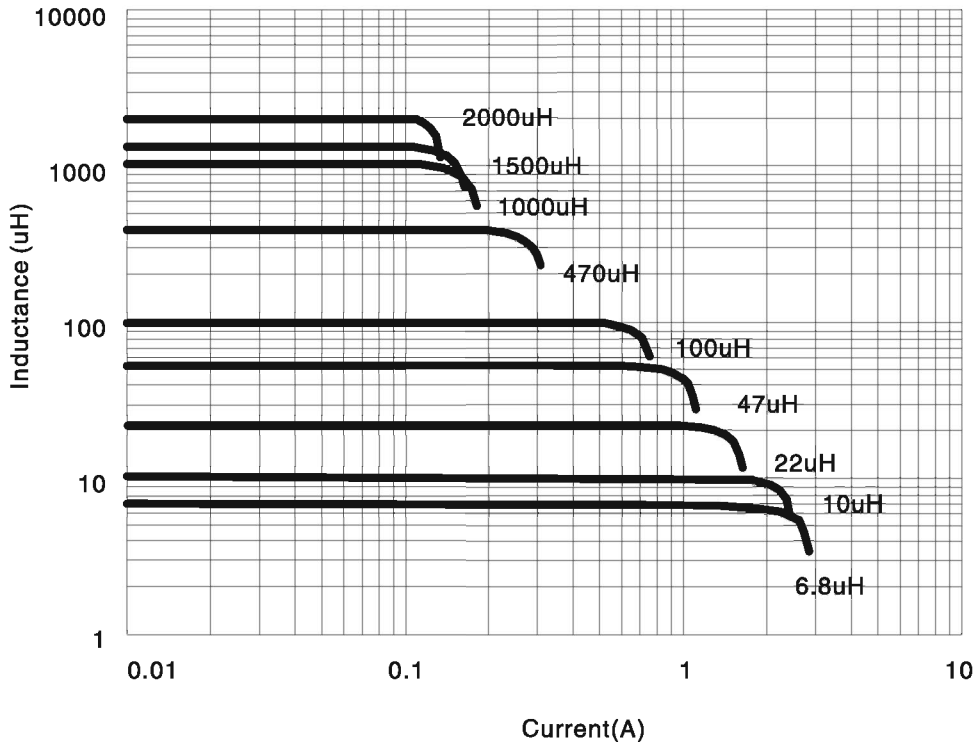

TYPICAL L VS FREQUENCY

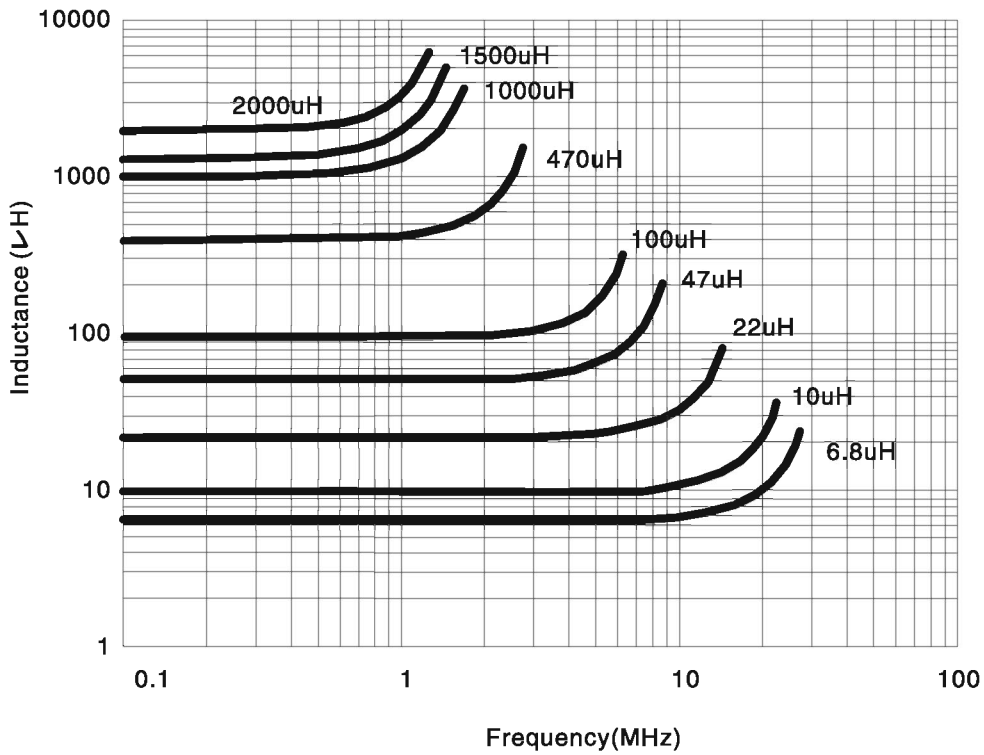

# COUPLED INDUCTORS, COMMON MODE CHOKES SDRH7342D SERIES



## FEATURES:

- Only 4.6 mm high and 7.5 mm square
- Ideal for use in both power line and signal line applications
- Common- and differential-mode filtering in a single device
- Up to 230 MHz differential mode cutoff frequency
- Can be used as coupled inductors for SEPIC applications
- RoHS compliant

## ELECTRICAL CHARACTERISTICS:

Partnumber	Common mode impedance Max (K $\Omega$ )	Cutoff frequency (MHz)	Inductance ( $\mu$ H)		DCR max ( $\Omega$ )	Isolation (Vrms)	I <sub>rms</sub> (A)
			Min	Nom			
SDRH7342D-2R5M	3.07 @ 53 MHz	89	2.00	2.5	0.033	200	2.17
SDRH7342D-3R3M	3.86 @ 50 MHz	70	2.64	3.3	0.037	200	2.05
SDRH7342D-4R7M	4.93 @ 37 MHz	55	3.76	4.7	0.051	200	1.74
SDRH7342D-5R6M	5.96 @ 34 MHz	67	4.48	5.6	0.063	200	1.57
SDRH7342D-6R8M	7.85 @ 31 MHz	79	5.44	6.8	0.070	200	1.49
SDRH7342D-8R2M	9.09 @ 32 MHz	55	6.56	8.2	0.075	200	1.44
SDRH7342D-100M	9.15 @ 24 MHz	63	8.00	10	0.10	200	1.24
SDRH7342D-120M	11.85 @ 22 MHz	47	9.60	12	0.12	200	1.14
SDRH7342D-150M	14.43 @ 20 MHz	53	12.0	15	0.13	200	1.09
SDRH7342D-180M	18.24 @ 18 MHz	38	14.4	18	0.17	200	0.95
SDRH7342D-220M	18.37 @ 15 MHz	49	17.6	22	0.22	200	0.84
SDRH7342D-270M	25.63 @ 14 MHz	42	21.6	27	0.25	200	0.79
SDRH7342D-330M	26.26 @ 14 MHz	41	26.4	33	0.27	200	0.76
SDRH7342D-390M	35.44 @ 11 MHz	42	31.2	39	0.38	200	0.64
SDRH7342D-470M	34.38 @ 11 MHz	38	37.6	47	0.42	200	0.61
SDRH7342D-560M	41.03 @ 7.9 MHz	40	44.8	56	0.46	200	0.58
SDRH7342D-680M	70.55 @ 8.5 MHz	52	54.4	68	0.60	200	0.51
SDRH7342D-820M	84.57 @ 7.4 MHz	26	65.6	82	0.68	200	0.48
SDRH7342D-101M	89.05 @ 6.6 MHz	24	80.0	100	0.77	200	0.45
SDRH7342D-121M	101.4 @ 6.4 MHz	22	96.0	120	1.03	200	0.39
SDRH7342D-151M	121.2 @ 5.5 MHz	19	120	150	1.35	200	0.34
SDRH7342D-181M	141.5 @ 4.6 MHz	20	144	180	1.52	200	0.32
SDRH7342D-221M	133.0 @ 4.8 MHz	25	176	220	1.72	200	0.30
SDRH7342D-271M	103.7 @ 3.6 MHz	18	216	270	2.41	200	0.25
SDRH7342D-331M	131.7 @ 3.8 MHz	9.1	264	330	2.70	200	0.24
SDRH7342D-391M	145.9 @ 3.1 MHz	11	312	390	3.05	200	0.23
SDRH7342D-471M	187.2 @ 2.7 MHz	11	376	470	4.00	200	0.20
SDRH7342D-561M	204.4 @ 2.6 MHz	8.1	448	560	4.43	200	0.19
SDRH7342D-681M	210.0 @ 2.2 MHz	3.3	544	680	5.00	200	0.18
SDRH7342D-821M	251.8 @ 2.4 MHz	6.6	656	820	6.80	200	0.15
SDRH7342D-102M	276.1 @ 2.1 MHz	5.1	800	1000	7.80	200	0.14

**PHYSICAL CHARACTERISTICS & WINDING:**

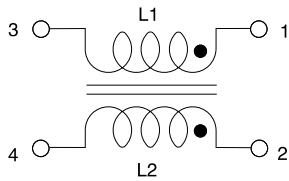
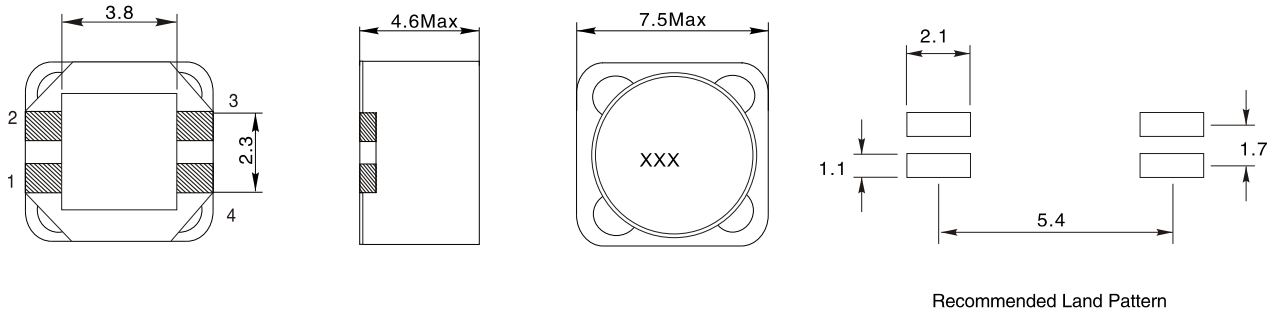

1. Frequency at which the differential mode attenuation equals -3dB
2. Inductance shown for each winding, measured at 100 kHz, 0.1 Vrms, 0 Adc on an Agilent/HP 4284A LCR meter or equivalent
3. DCR is for each winding.
4. Winding-to-winding isolation 500 Vrms, one minute
5. Current that causes a 40 °C temperature rise from 25 °C ambient. This information is for reference only and does not represent absolute maximum ratings
6. Electrical specifications at 25 °C
7. Ambient temperature -40 °C to +85 °C with Irms current. Maximum part temperature +125 °C (ambient + temp rise).
8. Storage temperature Component: -40 °C to +125 °C .
9. Tape and reel packaging: -40 °C to +80 °C

**PERFORMANCE CURVE:**

Typical Attenuation(Ref:50 Ohms)

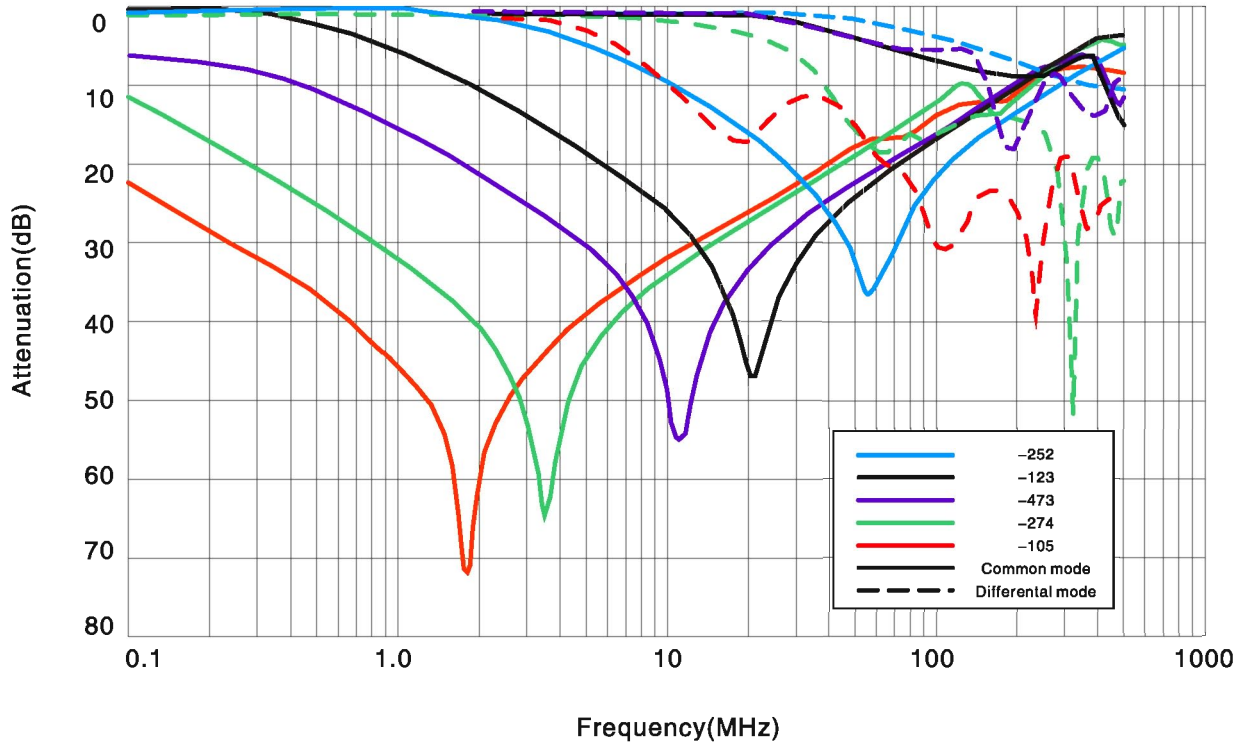

Typical Impedance vs Frequency

